

# QUICK GUIDE FOR PUMP SELECTION









# WHAT IS A WATER PUMP?

**A PUMP IS A MACHINE THAT CONVERTS ELECTRICAL POWER INTO ENERGY THAT IS TRANSMITTED TO THE WATER. THE TRANSMITTED ENERGY CAUSES DISPLACEMENT FOR THE WATER.**

All water pumps are composed of two basic selections: Electric motor and hydraulic section. The support is utilized to secure the pump to the base and prevent it from moving.



HYDRAULIC SECTION



SUPPORT



ELECTRIC MOTOR

## BASIC ELEMENTS OF THE HYDRAULIC SECTION

<b>HOUSING</b>	PUMP BODY. PROTECTS THE HYDRAULIC SECTION OF THE PUMP.
<b>IMPELLER</b>	CAUSES AND DIRECTS MOVEMENT OF THE WATER INSIDE THE PUMP.
<b>DIFFUSER</b>	IT TURNS THE ENERGY TRANSFERRED TO THE WATER BY THE IMPELLER INTO PRESSURE.
<b>MECHANICAL SEAL</b>	IT PREVENTS THE WATER FROM GET IN CONTACT WITH THE ELECTRIC MOTOR.
<b>O-RINGS</b>	ADAPT THE VARIOUS PARTS OF THE PUMP.

## BASIC COMPONENTS OF AN ELECTRIC MOTOR

<b>HOUSING</b>	PROTECTS THE INTERNAL PARTS OF THE ELECTRIC MOTOR.
<b>STATOR</b>	BASIC COMPONENT OF THE ELECTRIC MOTOR.
<b>SHAFT OR ROTOR</b>	TRANSMITS MOTION TO THE HYDRAULIC PART.
<b>FAN</b>	COOLS THE ELECTRIC MOTOR.
<b>BEARINGS</b>	ESTABLISH THE POSITION OF THE ROTOR AND ALLOW IT TO ROTATE.
<b>TERMINAL BOARD</b>	LETS THE ELECTRICAL POWER INPUT TO THE MOTOR.

# BASIC CONCEPTS

TO CHOOSE A PUMP WE NEED TO KNOW 2 BASIC VALUES: FLOWRATE AND LIFT PRESSURE OR HEIGHT (OR HEAD)

## FLOW RATE (Q)

$$Q = A \times v$$

**A:** area of the pipe  $\pi \times (d/2)^2$  [m<sup>2</sup>]

**v:** speed of liquid (water) in the pipe [m/s]

**Q:** the quantity of liquid (water) flowing through the pipe in a certain timespan.

**THE MOST COMMON MEASUREMENT UNITS:**

- m<sup>3</sup>/h
- 1 litre/s = 3,6 m<sup>3</sup>/h
- 1 litre/min = 0,06 m<sup>3</sup>/h

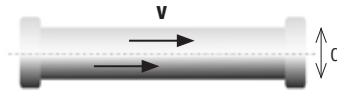

**We recommend you to use:**

$v \leq 1$  m/s → **DOMESTIC APPLICATIONS**

$v \leq 2$  m/s → **OTHER APPLICATIONS**

$v \leq 5$  m/s → **WASTE WATER APPLICATIONS**

## PRESSURE DROPS (HP)

Dynamic energy losses of the water due mainly to friction against the walls of the pipe and the accessories in a plant (elbow curves, valves, etc.).

Unless otherwise indicated we can assume that  $h_p$  will be equivalent to 20% of  $h_g$  (in "m" or bar).



## DELIVERY HEAD (HI)

The maximum possible height between the delivery port of the pump and the water outlet point (normally a tap)(m).

## SUCTION HEAD (HS)

The height between the water level in the sump and the suction port of the pump (m).

## GEOMETRICAL HEIGHT (HG)

The geometrical height from the water level in the sump to the most unfavourable water inlet point (m).

$$h_g = h_s + h_i \quad (\text{POSITIVE SUCTION})$$

## RESIDUAL PRESSURE (HR)

Pressure required at the most unfavourable water inlet point (TAP) (20 m unless otherwise specified)

## TOTAL WATER PRESSURE HEAD IN METERS (HT)

$$h_t = h_g + h_p + h_r$$

**THE MOST COMMON MEASUREMENT UNITS:**

- m.w.c. (metres water column) or m or m<sub>H<sub>2</sub>O</sub>
- 1 Kg/cm<sup>2</sup> ≈ 10 m.w.c.
- 1 bar ≈ 10 m.w.c.

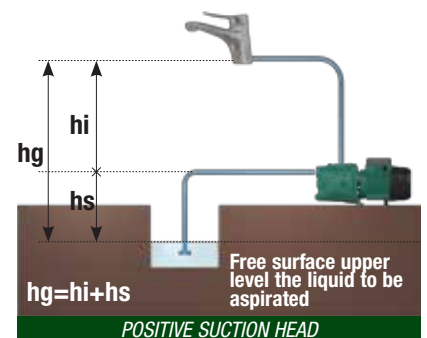
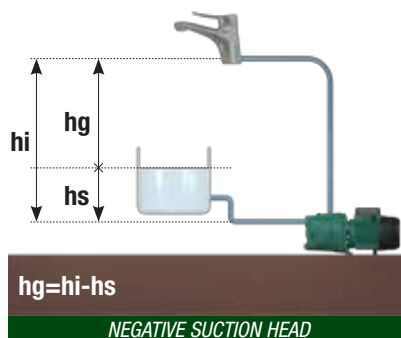

# IMPORTANT INFORMATION

## MINIMUM WATER CONSUMPTION IN SINGLE-FAMILY DOMESTIC SYSTEMS:

Kitchen + bathroom = 1,7 m<sup>3</sup>/h  
 Kitchen + bathroom + WC = 1,8 m<sup>3</sup>/h  
 Kitchen + 2 bathrooms = 2 m<sup>3</sup>/h  
 Kitchen + 3 bathrooms = 2,2 m<sup>3</sup>/h

## APPROXIMATE CONSUMPTION FOR GARDENS IN ACCORDANCE WITH SURFACE AREA

Surface (m <sup>2</sup> )	100	200	300	400
Flow rate (m <sup>3</sup> /h)	0,75	1,5	2,25	3

Assume we want to calculate the water flow rate required for a home with 1 KITCHEN and 2 BATHROOMS and 200 m<sup>2</sup> of garden space.  
 KITCHEN + 2 BATHROOMS + 200m<sup>2</sup> = 2m<sup>3</sup>/h + 1,5m<sup>3</sup>/h = 3,5m<sup>3</sup>/h

## FORMULAS UTILISED FOR PUMP SIZING:

	HEATING SYSTEM (CLOSED CIRCUIT*)	PRESSURIZATION
<b>FLOW Q</b>	$Q(l/s) = \frac{\text{Boiler H. Capacity (kcal/h)}}{\Delta t (^{\circ}\text{C}) \times 3600} = \frac{\text{Boiler H. Capacity (kW)} \times 860}{\Delta t (^{\circ}\text{C}) \times 3600}$ <p>We can consider:  <math>\Delta t^{\circ} \approx 20^{\circ}\text{C}</math> for heating systems with radiators  <math>\Delta t^{\circ} \approx 5-10^{\circ}\text{C}</math> for under-floor heating systems</p>	$Q(l/min) = n. \text{ of living units} \times 12 (l/min) \times 0,30$ <p><b>12 (l/min)</b> = average consumption for shower (user device with high flow rate) </p> <p><b>0,30</b> = we consider a contemporary factor expressed as a percentage (30% for residential buildings) **</p> <ul style="list-style-type: none"> <li>flats with 2 bathrooms → <b>+30% Q</b></li> <li>flats with 3 bathrooms → <b>+25% Q</b></li> <li>flats with 4 bathrooms → <b>+20% Q</b></li> </ul>
<b>HEAD H</b>	<p><b>H = differential pressure (Δp) = circuit pressure losses</b></p> <p>Circuit pressure losses can be calculated as a sum of the localized flow resistance of each component that composed the heating system (for example: valves, boiler, radiators, ...).</p> <p>To help you, we have provided a table (see pag. 35 indicating the friction loss in each component found in heating systems.</p>	<p><b>ht = hg + 20% hg + hr</b></p> <p><b>ht</b> = total losses of system or pressure (m).  <b>hg</b> = geometrical height from water level at suction to the most unfavourable offshoot (m).  <b>hs</b> = height from water level to pump suction port (m).  <b>hi</b> = most unfavourable height from pump discharge port to water inlet point (m).  <b>hr</b> = pressure required at the most unfavourable water offshoot (20 m unless otherwise specified).</p>

\* Heating system sample pag. 35

\*\* User devices flow rate sample pag. 7

## IT IS EASY TO CHOOSE THE MOST SUITABLE WATER PUMP BASED ON YOUR REQUIREMENTS

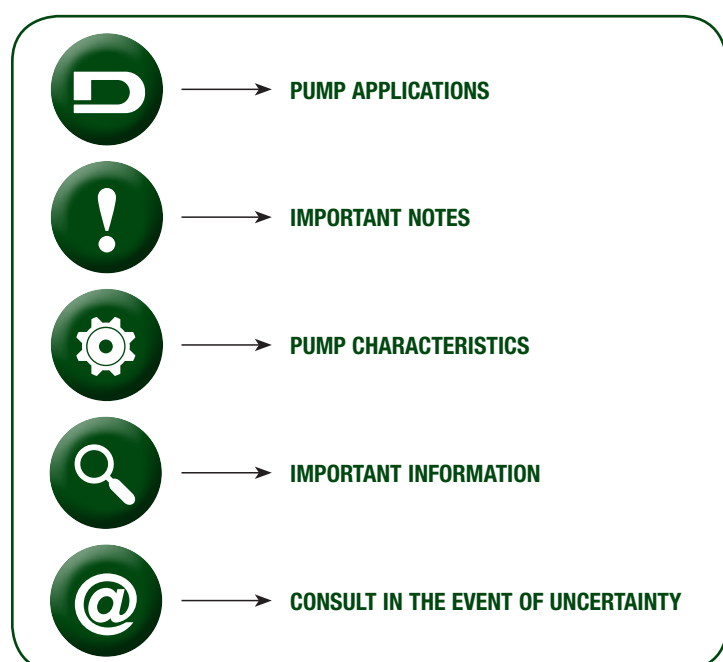

## NOTE



- The selection tables given in this manual have been developed for rapid orientation in the choice of suitable pumps. In the event of doubt, consult DAB Technical Department.
- For the calculations provided in this catalogue reference was made to the new CTE regulation (Technical Building Code).
- In the other cases not considered in the manual we recommend consulting DAB Technical Department.



# EFFORTLESS WATER LIFTING

## JET, JETINOX, JETCOM

Single-stage centrifugal pumps with Venturi system to allow self-priming up to 8 metres.



JET



JETINOX



JETCOM



## APPLICATION



- Water supply for single-family homes.
- Watering of small vegetable plots and gardens.
- Washing tunnels.
- And for other applications (consult DAB Technical Department).

## CHARACTERISTICS



- Flow rates from 0.4 to 10.5 m<sup>3</sup>/h with maximum pressure head of 62 m.
- The water temperature range must be between -10°C and +40°C.
- The pumped liquid must be clean, free of suspended solids or abrasive substances and chemically neutral.

## IMPORTANT



(PREARRANGED FOR USE WITH ACTIVE, SMART PRESS AND ACTIVE DRIVER PLUS CONTROL SYSTEMS)

- Self-priming pump up to 8 metres;
- Install the pump as close as possible to the liquid source;
- The inside diameter of the pipe must be at least equal to the diameter of the pump ports;
- When the pressure head exceeds four metres, we recommend using a lift pipe with bigger interval diameter than the one of the suction port;
- Install a foot valve or check valve on the suction line;
- Do not start the pump until it has been completely filled with liquid;
- To avoid motor to overheating, we recommend not to exceed the limit of 20 startings/hour;
- Fixing the pump securely to its base helps absorbing vibration caused by its operation;
- The pump must be installed in horizontal position;

USER DEVICE	FLOW RATE (l/min)
Toilet with rapid flow valve	90
Bath	15
Shower	12
Washing machine	12
Dishwasher	10
Sink	9
Washbasin	6
Bidet	6
Toilet with flush tank	6

# SELECTION OF JET, JETINOX AND JETCOM PUMPS

## EXAMPLE

Assume we wish to supply water from a nearby well to a detached home composed of ground floor and first floor. The installer has informed us that the house has 1 KITCHEN and 2 BATHROOMS. The water level in the well with respect to the pump suction port is located at  $h_s = 5\text{ m}$ .

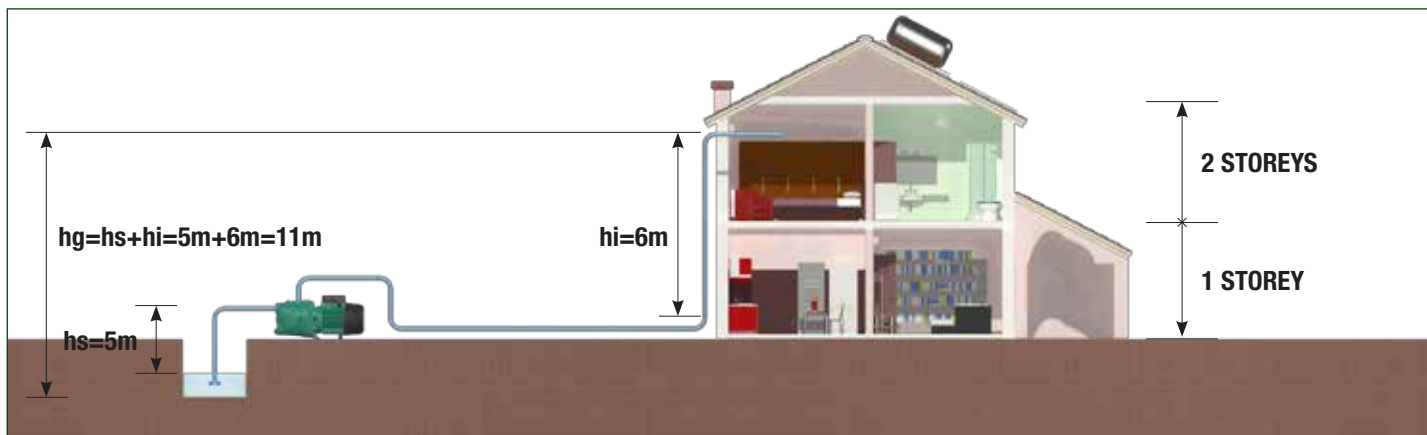

Unless differently specified,  $h_p$  (system pressure drop) = 20% of  $h_g$ .  
Height of each storey = 3 m.



	KITCHEN + BATHROOM	KITCHEN + BATHROOM + WC	KITCHEN + 2 BATHROOMS	KITCHEN + 2 BATHROOMS + 100 m <sup>2</sup> GARDEN
1 STOREY	JET 82 / $h_{smax} = 7\text{m}$	JET 102 / $h_{smax} = 7\text{m}$	JET 102 / $h_{smax} = 7\text{m}$	JET 132 / $h_{smax} = 7\text{m}$
2 STOREYS	JET 102 / $h_{smax} = 7\text{m}$	JET 102 / $h_{smax} = 6,5\text{m}$	<b>JET 112 / <math>h_{smax} = 6,5\text{m}</math></b>	JET 132 / $h_{smax} = 7\text{m}$
3 STOREYS	JET 132 / $h_{smax} = 7\text{m}$	JET 132 / $h_{smax} = 7\text{m}$	JET 151 / $h_{smax} = 7\text{m}$	JET 151 / $h_{smax} = 5,5\text{m}$

- \* Max  $h_s$ : this is the maximum suction height for correct operation of the installed pump.
- \* The data given in the table and in the graph curve are valid for JET, JETINOX and JETCOM pumps.
- \* For the other cases not addressed in the table, consult DAB Technical Department.
- \* The pumps can be single-phase or three-phase (see DAB documentation).



## THEORETICAL SELECTION

### Available data:

1. N° of storeys = 2
2. N° of bathrooms = 2
3.  $h_i = 3\text{ m} \times 2\text{ storeys} = 6\text{ m}$
4.  $h_s = 5\text{ m}$
5.  $h_g = 5\text{ m} + 6\text{ m} = 11\text{ m}$

### Flow rate and pressure head: (see page 6)

$h_t = 11 + 2,2\text{ m} + 20\text{ m} = 33,2\text{ m}$   
 $Q = 2\text{ m}^3/\text{h}$

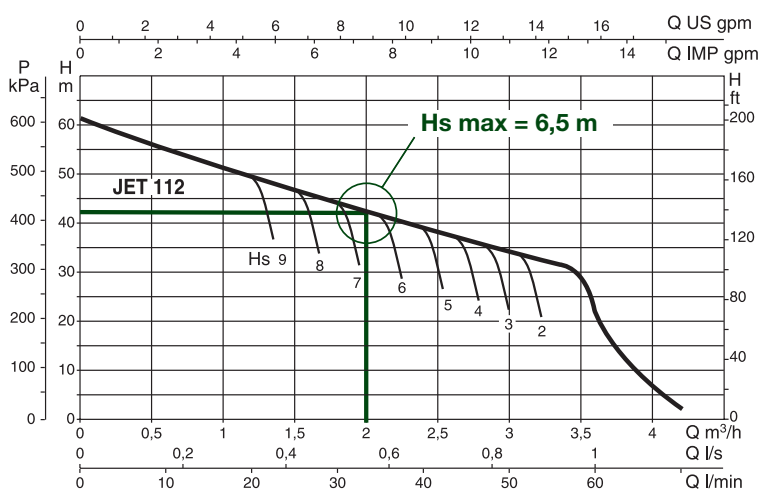

$h_{s\text{ max}}$  (max draft) = 6,5m.

This means that this pump will work correctly, always and when the level difference between the end of the suction pipe and the pump suction port is less than or equal to 6.5 m. In this example  $h_s = 5\text{ m}$ , i.e. less than 6.5 m, hence the selected pump will work good.



# THE SILENT POWER OF WATER

## EUROINOX, EURO and EUROCOM

Multistage centrifugal pump (3 to 5 impellers) featuring higher pressure values with quiet operation.



EURO



EUROINOX



EUROCOM



## APPLICATION



- Water supply for single-family homes.
- Watering of small vegetable plots and gardens.
- Washing tunnels.
- And for other applications (consult DAB Technical Department).

## CHARACTERISTICS



- Flow rates from 0.4 to 7.2 m<sup>3</sup>/h with maximum pressure head of 72 m.
- The water temperature range must be between 0 °C and 40 °C.
- The pumped liquid must be clean, free from suspended solids or abrasive substances and chemically neutral.

## IMPORTANT



(PREARRANGED FOR USE WITH ACTIVE, SMART PRESS AND ACTIVE DRIVER PLUS CONTROL SYSTEMS)

- Self-priming pump up to 7 metres (only Euroinox).
- Install the pump as close as possible to the liquid source.
- The internal diameter of the pipe must be at least equal to the diameter of the pump port.
- When the pressure head exceeds four metres, we recommend using a lift pipe of bigger internal diameter than the diameter of the suction port (only Euroinox).
- Install a foot valve or check valve on the suction line.
- Do not start the pump until it has been completely filled with liquid.
- To avoid motor overheating, we recommend not exceeding the limit of 20 startings/hour.
- Fixing the pump securely to its base helps absorbing vibrations caused by its operation.
- The pump must be installed in horizontal position.

# SELECTION OF EUROINOX, EURO AND EUROPRO

## EXAMPLE

Assume we wish to supply water from a nearby well to a detached bungalow. The installer informs us that this bungalow has 1 KITCHEN and 2 BATHROOMS and it is also necessary to water 300 m<sup>2</sup> garden. The water level is 1 m below the position of the pump.

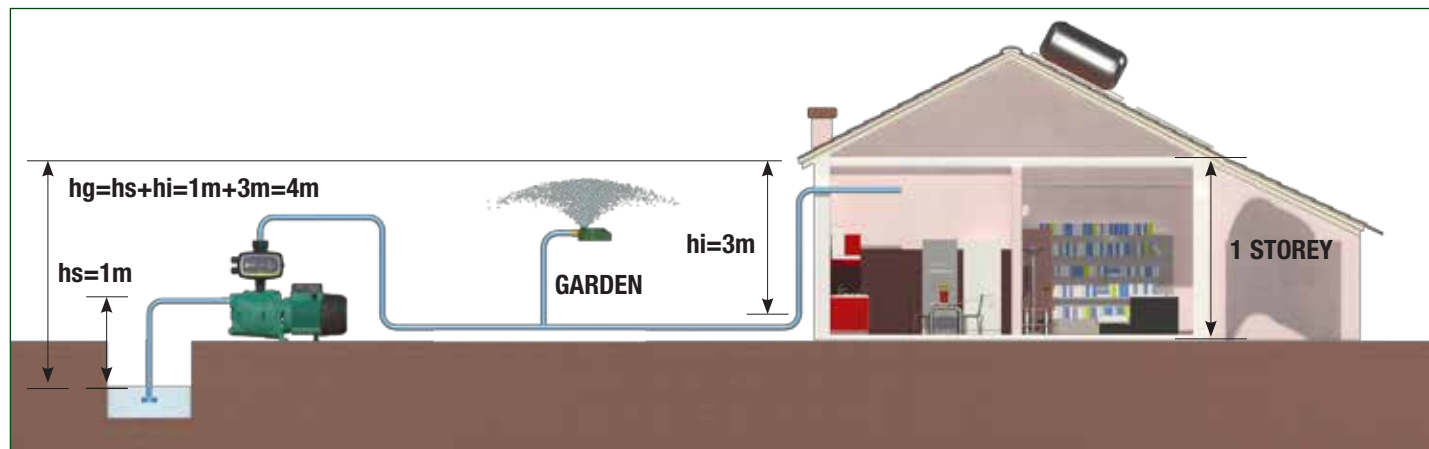

Unless otherwise indicated,  $h_p$  (system pressure drop) = 20% of  $h_g$ .  
Height of each storey = 3 m.

	KITCHEN + BATHROOM	KITCHEN + BATHROOM + WC	KITCHEN + 2 BATHROOMS	KITCHEN + 2 BATHROOMS + 300 m <sup>2</sup> GARDEN
1 STOREY	EUROINOX 30/30	EUROINOX 30/30	EUROINOX 30/50	EUROINOX 30/80
2 STOREYS	EUROINOX 40/30	EUROINOX 40/30	EUROINOX 40/50	EUROINOX 30/80
3 STOREYS	EUROINOX 40/30	EUROINOX 40/30	EUROINOX 40/50	EUROINOX 40/80

\* The data given in the table and in the graph curve are valid for EURO, EUROINOX and EUROCOM pumps.  
\* For the other cases not addressed in the table, consult DAB Technical Department.  
\* The pumps can be single-phase or three-phase (see DAB documentation).

## THEORETICAL SELECTION

### Given data:

- N<sup>o</sup> of storeys = 1
- N<sup>o</sup> of bathrooms = 2
- $h_i = 3\text{m} \times 1 \text{ storey} = 3\text{m}$
- $h_s = 1\text{m}$
- $h_g = 1\text{m} + 3\text{m} = 4\text{m}$
- 300 m<sup>2</sup> garden

### Flow rate and pressure head: (see page 6)

$h_t = 4\text{m} + 0,8\text{m} + 20\text{m} = 24,8\text{m}$   
 $Q = 2\text{ m}^3/\text{h} + 2,25\text{ m}^3/\text{h} \text{ (garden)} = 4,25\text{ m}^3/\text{h}$

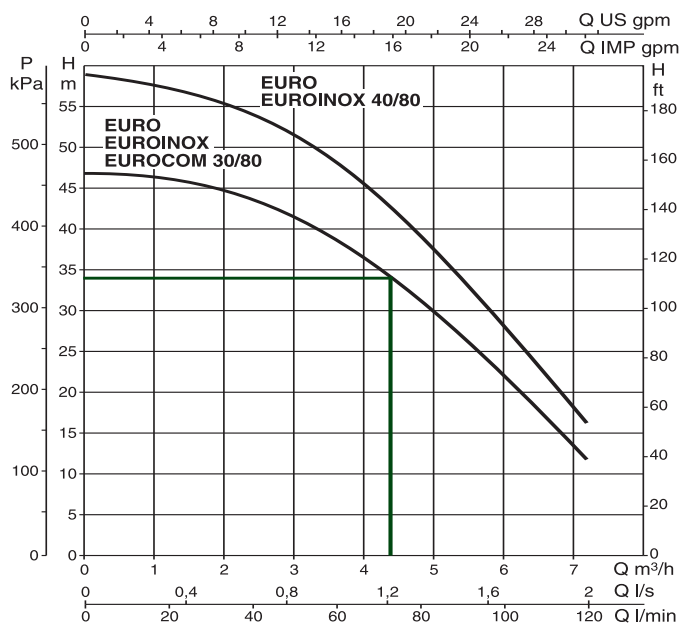

# WATER CONTROL AT YOUR DISCRETION

## AQUAJET, SMART PRESS AND ACTIVE SYSTEM (Automatic pressure control systems)



### CHARACTERISTICS



- The system is equipped with an expansion tank with internal diaphragm, pressure gauge, union, and flexible hose.
- The system allows controlling the pressure by adjusting the pressure switch and the water storage in the tank.

### CHARACTERISTICS



- The system allows maintaining a minimum pressure of 1.5 bar restarting the pump when the system pressure drops through this value.
- Dry run protection system.
- Smart Press is equipped with indicator lights to monitor the correct operation of the equipment.
- System can be manually reset.
- Prevents from water hammer.

## (JET, JETINOX, JETCOM) + SMART PRESS (SP) / AQUAJET

	KITCHEN + BATHROOM	KITCHEN + BATHROOM + LAUNDRY ROOM	KITCHEN + 2 BATHROOMS
1 STOREY	JET 82 M + SP / h <sub>smax</sub> = 7m	JET 102 M + SP / h <sub>smax</sub> = 7m	JET 102 M + SP / h <sub>smax</sub> = 7m
2 STOREYS	JET 102 M + SP / h <sub>smax</sub> = 7m	JET 102 M + SP / h <sub>smax</sub> = 7m	JET 112 M + SP / h <sub>smax</sub> = 7m
3 STOREYS	JET 102 M + SP / h <sub>smax</sub> = 7m	JET 132 M + SP / h <sub>smax</sub> = 7m	

## (EUROINOX, EURO, EUROCOM) + SMART PRESS (SP)

	KITCHEN + BATHROOM	KITCHEN + BATHROOM + LAUNDRY ROOM	KITCHEN + 2 BATHROOMS
1 STOREY	EUROINOX 30/30 M + SP	EUROINOX 30/30 M + SP	EUROINOX 40/50 M + SP
2 STOREYS	EUROINOX 40/30 M + SP	EUROINOX 40/30 M + SP	EUROINOX 40/50 M + SP
3 STOREYS	EUROINOX 40/30 M + SP	EUROINOX 40/30 M + SP	EUROINOX 40/50 M + SP

### NOTE



- Max hs: this is the maximum suction height for correct operation of the installed pump.
- For the other cases not addressed in the table, consult DAB Technical Department.



# WATER CONTROL AT YOUR DISCRETION

## ACTIVE SYSTEM



## CHARACTERISTICS



- The system resets automatically by starting up periodically.
- Controls the pump and prevents the pump from running dry.
- Ensures stability of pressure in the water circuit.
- Allows electronic pressure control.
- Eliminates water hammer.
- Compact dimensions.
- Built-in check valve, pressure gauge and flexible connection hose.
- Integrated water temperature sensor: stops the pump when the temperature exceeds 40°C.

## IMPORTANT



- Restarting pressure adjustable between 1.5 and 2.5 bar.
- Facility to connect an audible or visual alarm.
- In the event of an electronic fault, the pump can be connected directly to the power supply mains.
- A foot valve must be installed at the end of the suction pipe to prevent the pump from emptying.
- Before starting the pump it must be completely filled with water to avoid the formation of air pockets.
- The pump must always be installed in horizontal position.

## NOTE



- Max hs: this is the maximum suction height for correct operation of the installed pump.
- For the other cases not addressed in the table, consult DAB Technical Department.

## ACTIVE (Jet, Jetinox, Jetcom)

	KITCHEN + BATHROOM	KITCHEN + BATHROOM + WC	KITCHEN + 2 BATHROOMS
1 STOREY	ACTIVE J 82 M / hsmax = 7m	ACTIVE J 102 M / hsmax = 7m	ACTIVE J 102 M / hsmax = 7m
2 STOREYS	ACTIVE J 102 M / hsmax = 7m	ACTIVE J 102 M / hsmax = 7m	ACTIVE J 112 M / hsmax = 7m
3 STOREYS	ACTIVE J 102 M / hsmax = 7m	ACTIVE J 132 M / hsmax = 7m	

## ACTIVE (Euroinox, Euro, Eurocom)

	KITCHEN + BATHROOM	KITCHEN + BATHROOM + WC	KITCHEN + 2 BATHROOMS
1 STOREY	ACTIVE EI 30/30 M	ACTIVE EI 30/30 M	ACTIVE EI 30/50 M
2 STOREYS	ACTIVE EI 40/30 M	ACTIVE EI 40/30 M	ACTIVE EI 40/50 M
3 STOREYS	ACTIVE EI 40/30 M	ACTIVE EI 40/30 M	ACTIVE EI 40/50 M

## AUTOMATIC ELECTRO PUMP (CONTROL SYSTEM)

The inverter for cold water pumps of up to 7,5 HP.



ACTIVE DRIVER PLUS



JETINOX



PULSAR



### WHICH ARE THE AVAILABLE ACTIVE DRIVER PLUS MODELS?

MODEL	CURRENT (A)	POWER SUPPLY 50 HZ	PUMPS POWER SUPPLY	PER PUMP
A.D PLUS M/M 1.1	8,5	1 x 230 V	1 x 230 V	PULSAR/DRY, 4" PUMP JET/INOX, EURO/INOX
A.D PLUS M/M 1.5	11	1 x 115 V	1 x 115 V	PULSAR/DRY, 4" PUMP JET/INOX, EURO/INOX
		1 x 230 V	1 x 230 V	
A.D PLUS M/M 1.8	14	1 x 115 V	1 x 115 V	PULSAR/DRY, 4" PUMP JET/INOX, EURO/INOX
		1 x 230 V	1 x 230 V	
A.D PLUS M/T 1.0	4,7	1 x 230 V	3 x 230 V	PULSAR/DRY, 4" PUMP JET/INOX, EURO/INOX
A.D PLUS M/T 2.2	10,5	1 x 230 V	3 x 230 V	PULSAR/DRY, 4" PUMP JET/INOX, EURO/INOX
A.D PLUS T/T 3.0	7,5	3 x 400 V	3 x 400 V	PULSAR/DRY, 4" PUMP JET/INOX, EURO/INOX
A.D PLUS T/T 5.5	13,3	3 x 400 V	3 x 400 V	PULSAR/DRY, 4" PUMP JET/INOX, EURO/INOX

## CHARACTERISTICS

- Keeps system pressure constant against variable flow rate demand.
- Significant facilitation of programming.
- Regulates and controls pump speed.
- Protects pump against dry running and, in compliance with regulations, against overcurrent conditions.
- In the event of a shutdown the device resets automatically.
- In the event of mains voltage drop, ACTIVE DRIVER PLUS restabilises the system when the voltage gets restored to 220 V (-20%- +10%).
- Integrated check valve.
- 2 different setpoints can be programmed (except for models M/M 1.1 and M/T 1.0).
- Maximum pressure 13 bar.



## IMPORTANT

- Recommended maximum flow rate 18m<sup>3</sup>/h.
- Can be installed on any cold water pump complying with the same criteria of the ACTIVE DRIVER PLUS.
- The choice of ACTIVE DRIVER PLUS is made in accordance with the mains power supply and the pump rated input current.
- Always install in vertical position.
- Install an expansion vessel with capacity lower than 20 l at approximately 1 m beyond the ACTIVE DRIVER PLUS output.
- No protections control panel is required.



## NOTE

- The ACTIVE DRIVER PLUS is chosen in compliance with the nominal pump current input and type of power supply.
- For further information consult the DAB Technical Department.



# DOMESTIC ELECTRONIC PRESSURISATION SYSTEM

## E.SYBOX MINI

E.sybox mini is the new integrated system by DAB for water pressure boosting in domestic and residential applications.



## CHARACTERISTICS



- In-built pressure and flow sensors.
- Inverter for control and achieving constant pressure.
- Easy adjustable functioning.
- Dry running, overcurrent, overheating and anticycling protections.
- Self-priming multistage pump (up to 8 meters).
- High-resolution LCD orientable display.
- Integrated expansion vessel of 1 litre.
- Integrated check valve.
- Water cooled motor (very SILENT system).

## APPLICATION



- Overall home water irrigation supply.
- Washing systems.
- For other applications consult DAB Technical Department.

## IMPORTANT



- The system can be installed in different configurations: horizontal, vertical, hiving at the wall.
- The internal diameter of the pipe must be at least equal to the diameter of the pump ports.
- Install a foot valve or chek valve in suction lift installation.
- Do not start the system before it's been filled with water.
- Be sure the charge of the integrated tank is 0,7 bar less than the set pressure.
- No electrical protections required.

## EXAMPLE

The selection is simple: e.sybox is capable of meeting all the application requirements of a small to medium house.

	KITCHEN + BATHROOM	KITCHEN + BATHROOM + WC	KITCHEN + 2 BATHROOMS	KITCHEN + 2 BATHROOMS + 50 m <sup>2</sup> GARDEN
1 STOREY	e.sybox mini	e.sybox mini	e.sybox mini	e.sybox mini
2 STOREYS	e.sybox mini	e.sybox mini	e.sybox mini	-
3 STOREYS	e.sybox mini	e.sybox mini	-	-

For the other cases not addressed in the table, consult DAB Technical Department.





# ELECTRONIC WATER PRESSURE SYSTEM

## E.SYBOX

E.sybox is the new integrated system by DAB for water pressure boosting in domestic and residential applications.



## CHARACTERISTICS



- In-built pressure and flow sensors.
- Inverter for control and achieving constant pressure.
- Easy adjustable functioning.
- Dry running, overcurrent, overheating and anticycling protections.
- Self-priming multistage pump (up to 8 meters).
- High-resolution LCD orientable display.
- Integrated expansion vessel of 1 litre.
- Integrated check valve.
- Water cooled motor (very SILENT system).

## APPLICATION



- Wireless communication.
- Complete home water supply.
- Washing system.
- For other applications consult Technical Department.

## IMPORTANT



- The system can be installed in different configuration: horizontal, vertical, on the wall.
- The inside diameter of the pipe must be at least equal to the diameter of the pump ports.
- Install a foot valve or check valve in suction lift installation.
- Do not start the system before it's been filled with liquid.
- Take care that the charge of the integrated tank is 0,7 bar less than the set pressure.
- An electrical protective panel is not required.
- The system can communicate Wirelessly with other e.sybox so as it's easy to do booster set up to 4 units.

## EXAMPLE

The selection is easy because for single-house application e.sybox is suitable for all the possibilities.

	KITCHEN + BATHROOM	KITCHEN + BATHROOM + WC	KITCHEN + 2 BATHROOMS	KITCHEN + 2 BATHROOMS + 100 m <sup>2</sup> GARDEN
1 STOREY	e.sybox	e.sybox	e.sybox	e.sybox
2 STOREYS	e.sybox	e.sybox	e.sybox	e.sybox
3 STOREYS	e.sybox	e.sybox	e.sybox	e.sybox

For the other cases not addressed in the table, consult DAB Technical Department.



# SELECTION OF THE E.SYBOX

## SELECTION TABLE SINGLE E.SYBOX FOR APARTMENT BUILDING

Table valid for a storage tank at atmospheric pressure. If the tank is pressurized for 8 pressure m in the tank you should consider 3 storeys less.

	MAX N° OF APART. + BATHROOM	MAX N° OF APART. + 2 BATHROOM	MAX N° OF APART. + 3 BATHROOM
1 STOREY	9 apart.	5 apart.	4 apart.
2 STOREYS	8 apart.	5 apart.	4 apart.
3 STOREYS	8 apart.	5 apart.	4 apart.
4 STOREYS	7 apart.	4 apart.	
5 STOREYS	7 apart.		
6 STOREYS	6 apart.		

Assume we wish to supply water to a small apartment building. The installer informs us that the building has 3 storeys with 6 apartment, and each apartment has only one bathroom. Looking at the table the e.sybox can satisfy the requested installation.

## THEORETICAL SELECTION

### Given data:

- N° of storeys = 3
- N° of apartment = 6
- N° of bathroom/apartment = 1

### Flow rate and pressure head: (see page 6)

$$\begin{aligned}
 h_i &= 3\text{m} \times 3 \text{ floor} = 9 \text{ m} \\
 h_s &= 0 \text{ m} \\
 h_g &= 0 + 9 = 9 \text{ m} \\
 h_t &= 9\text{m} + 20\%(9\text{m}) + 20\text{m} = 30,8 \text{ m} \\
 Q &= 11 \text{ l/min} \times 6 = 66 \text{ l/min}
 \end{aligned}$$

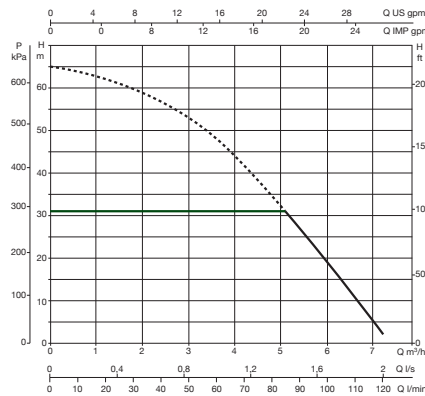

## SELECTION TABLE TWIN E.SYBOX FOR APARTMENT BUILDING

With a storage tank at atmospheric pressure. If the tank is pressurized for 8 pressure m in the tank you should consider 3 storeys less.

	MAX N° OF APART. + BATHROOM	MAX N° OF APART. + 2 BATHROOM	MAX N° OF APART. + 3 BATHROOM
1 STOREY	17 apart.	11 apart.	8 apart.
2 STOREYS	16 apart.	10 apart.	8 apart.
3 STOREYS	16 apart.	10 apart.	8 apart.
4 STOREYS	15 apart.	9 apart.	7 apart.
5 STOREYS	14 apart.	8 apart.	7 apart.
6 STOREYS	13 apart.	8 apart.	6 apart.
7 STOREYS	12 apart.	7 apart.	
8 STOREYS	11 apart.		
9 STOREYS	9 apart.		

We need to supply water to a small apartment building with 6 storeys and 15 apartments each with only one bathroom.

The building has a pre-vessel pressurized at 1,5 bar. Hence we have to consider instead of 6 storeys, 6-4=2 storeys. Looking at the table, the e.sybox twin is necessary.

## THEORETICAL SELECTION

### Given data:

- N° of storeys = 6
- N° of apartments = 15
- N° of bathroom/apartment = 1
- $h_s = -1,5 \text{ bar}$

### Flow rate and pressure head: (see page 6)

$$\begin{aligned}
 h_i &= 3 \text{ m} \times 6 \text{ floor} = 18 \text{ m} \\
 h_s &= -1,5 \text{ bar} = -15 \text{ m} \\
 h_g &= -15 + 18 = 3 \text{ m} \\
 h_t &= 3 \text{ m} + 20\% (18 \text{ m}) + 20 \text{ m} = 26,6 \text{ m} \\
 Q &= 11 \text{ l/min} \times 15 = 165 \text{ l/min}
 \end{aligned}$$

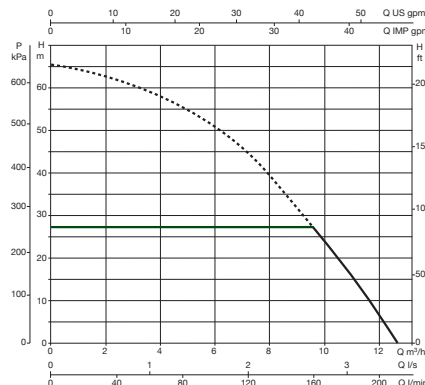

## E.SYBOX - ACCESSORIES

	<h3>e.sydock</h3> <p>Thanks to the 4 plumbing configuration possibilities it offers an even more rapid installation, easy and flexible. It is complete with all the interfaces required to connect it to the system. It is supplied with anti vibration feet to ensure the same quietness as e.sybox.</p>
	<h3>E.SYTWIN</h3> <p>E.sytwin is the evolution of e.sydock, whole benefits maintains, for the creation of groups of pumps. E.sytwin offers exceptional performance thanks to the possibility of combined operation with a 50% reduced size compared to any other equivalent traditional system.</p>
	<h3>E.SYWALL</h3> <p>Kit complete with brackets, screws, dowels and two anti vibration accessories.</p>
	<h3>E.SYTANK</h3> <p>Tank specially studied to better integrate with e.sybox and equipped with:</p> <ul style="list-style-type: none"> <li>• e.sydock (specially versioned) for a quick connection.</li> <li>• suction hose with foot valve</li> <li>• filling valve for the water supply with float</li> <li>• Overflow</li> <li>• flow connection (delivery)</li> <li>• preparation for ground mounting</li> <li>• inspection plug</li> </ul> <p>Capacity 500 l with the possibility of expansion on 3 sides.</p>
	<h3>E.SYTANK AUXILIARY CISTERN</h3> <p>The E.SYTANK AUXILIARY CISTERN is supplied without any fittings or the E.SYDOCK. The tank has a modular design to easily couple with other E.SYTANK units, making the system expandable to the necessary capacity. It can be connected on three sides (laterally and posteriorly) using the E.SYTANK COUPLING KIT.</p>
	<h3>E.SYTANK COUPLING KIT</h3> <p>The E.SYTANK COUPLING KIT is composed of a PVC sleeve with gaskets (D.160 mm L=150), two PVC aligning pipes (D.50mm x L=60) and a connecting ring nut for a 2-pump option. It allows the connection of several E.SYTANK units or between E.SYTANK and E.SYTANK AUXILIARY CISTERN.</p>
	<h3>E.SYTANK OPTIONAL DELIVERY KIT</h3> <p>Composed of a 1" PP pipe. It allows an auxiliary delivery for single tank systems or with the COUPLING KIT it allows several E.SYTANK and E.SYBOX systems to be linked together and to create pressure boosting units with several pumps and tanks.</p>
	<h3>e.sylink</h3> <p>E.sylink is the DAB accessory with wireless interface 802.15.4, designed to allow the E.SYBOX to use 4 digital inputs (pressure switch, float, etc.), to control 2 relay outputs (alarms, etc.) and to offer the possibility of connecting an auxiliary pressure sensor.</p>
	<h3>KIT E.SYLINK*</h3> <p>e.sylink with power supplier and electric box.</p>
	<h3>KIT E.SYLINK + PRESSOSTATE*</h3> <p>e.sylink with power supplier, panel and pressure switch.</p>

\*PROVIDED TO BE WIRED



# 4" PUMPS: the depth of the water has never been a problem

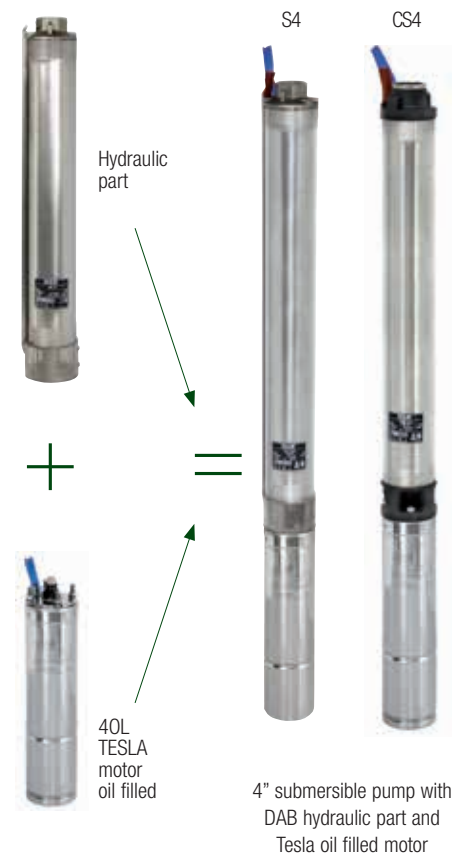
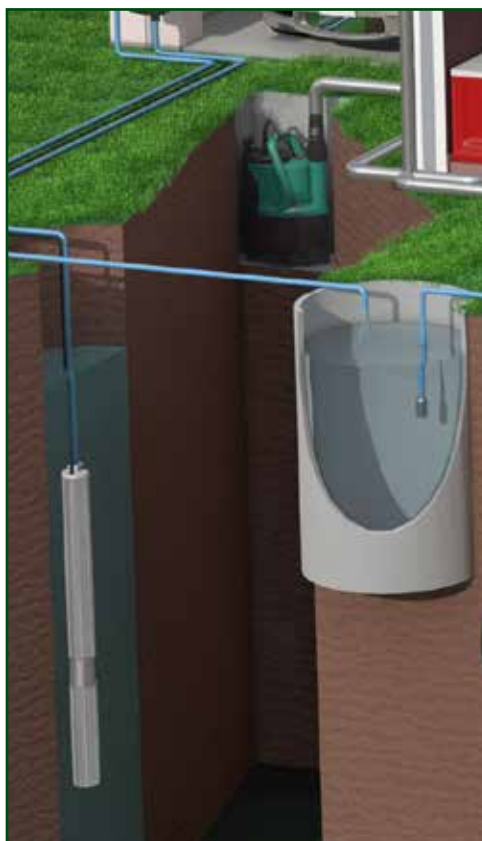
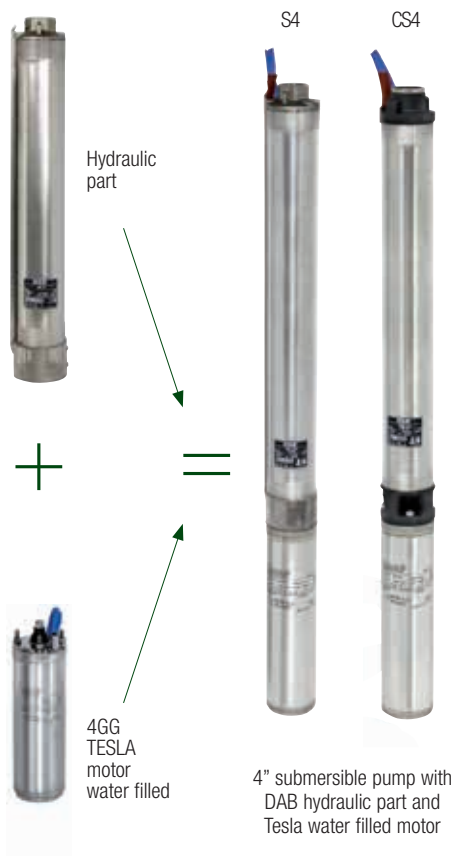

## APPLICATION



- Water supply for single-family houses.
- Watering of vegetable plots and gardens.
- Filling of storage tanks and cisterns.
- Washing tunnels.
- Other applications (consult DAB Technical Department).

## CHARACTERISTICS



- Suitable for installation in wells (or tanks).
- Pump with integrated check valve.
- Flow rates from 0.24 to 24 m<sup>3</sup>/h with heads of up to 320 m.
- Maximum permissible sand quantity: 120 g/m<sup>3</sup>.
- Water temperature between 0 °C and 40 °C.

## IMPORTANT



- Install a check valve downstream the pump at a distance of about 2 m to prevent from water hammer effects.
- Keep the pump raised at minimum 1 m from the bottom of the well.
- Install the necessary devices to protect the pump, e.g. the ACTIVE DRIVER PLUS, the CONTROL BOX etc. (In the event of doubt, consult DAB Technical Department).
- The cable cross section depends on the depth of installation of the pump. (In the event of doubt, consult DAB Technical Department).
- Maximum number of startings/hour = 20 (this value can be increased when using the ACTIVE DRIVER PLUS).
- Check the direction rotation of the pump (three-phase version).
- It is good practice to use a discharge pipe of the same internal diameter of the pump discharge port.
- Tank installations require motor sleeve.

## NOTE



The hydraulic part and the motor can be supplied together or separately.

# SELECTION OF 4" PUMP

## EXAMPLE

Assume we wish to install a 4" pump to supply water to a 2 storeys detached house. We know that the house has 1 KITCHEN and 2 BATHROOMS (one of which on the upper floor). The water is available 70 m deep underground.

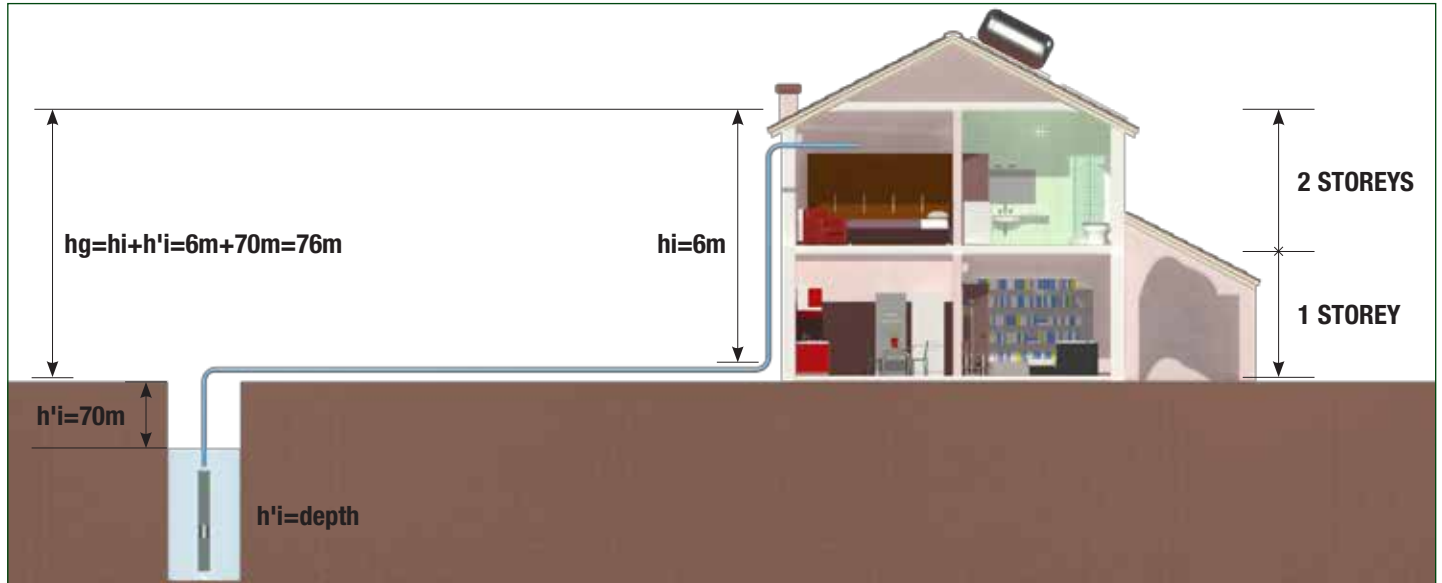

Unless otherwise specified,  $h_p$  (system pressure drop) = 20% of  $h_g$ .  
Height of each storey = 3 m.



	KITCHEN + BATHROOM	KITCHEN + BATHROOM + WC	KITCHEN + 2 BATHROOMS	KITCHEN + 2 BATHROOMS + 100 m <sup>2</sup> GARDEN
1 STOREY	S4B - 32	S4B - 32	S4C-25	S4C-32
2 STOREYS	S4B - 32	S4B - 32	S4C-25	S4C-32
3 STOREYS	S4B - 32	S4B - 32	S4C-25	S4C-32

\* The pumps can be single-phase or three-phase (see DAB documentation).  
\* For the other cases not addressed in the table, consult DAB Technical Department.



## THEORETICAL SELECTION

### Given data:

- N<sup>o</sup> of bathrooms = 2
- N<sup>o</sup> of storeys = 2
- $h_g = 70 \text{ m (depth)} + (3\text{m} \times 2 \text{ storeys}) = 76 \text{ m}$

### Flow rate and pressure head: (see page 6)

$h_t = 76 \text{ m} + 15.6 \text{ m} + 20 \text{ m} = 106.7 \text{ m}$   
 $Q = 1,7 \text{ m}^3/\text{h}$

The selected pump is an S4C-25 model.

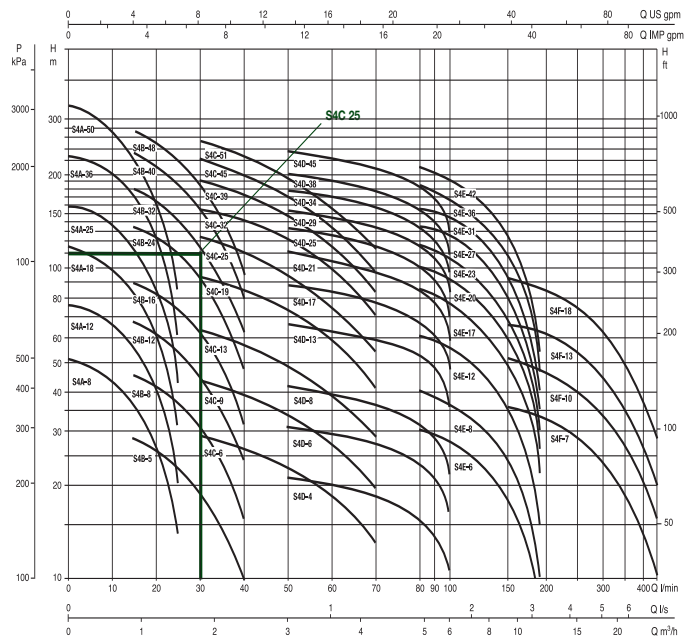

# PULSAR, DIVER AND DIVERTRON PUMP SELECTION

## PULSAR, DIVER AND DIVERTRON

Multi-stage close-coupled submersible pumps.



PULSAR  
WITH FLOAT



PULSAR



DIVER



DIVERTRON



## APPLICATION



- Water supply for single-family houses.
- Watering of vegetable plots and gardens.
- Filling of storage tanks and cisterns.
- Washing tunnels.
- Other applications (consult DAB Technical Department).

## CHARACTERISTICS



- Suitable for installation in wells.
- Very quiet operation.
- Flow rates from 0.9 to 7.2 m<sup>3</sup>/h with heads of up to 86 m.
- Maximum permissible sand quantity: 50 g m<sup>3</sup>.
- Maximum immersion depth: 20 m.

## IMPORTANT



- Install a check valve downstream the pump at a distance of about 2 m to prevent from water hammer effects.
- Keep the pump raised at minimum 1 m from the bottom of the well.
- Install the necessary devices to protect the pump, e.g. the ACTIVE DRIVER PLUS, the CONTROL BOX etc. (In the event of doubt, consult DAB Technical Department).
- The cable cross section depends on the depth of installation of the pump. (In the event of doubt, consult DAB Technical Department).
- Maximum number of startings/hour = 20 (this value can be increased when using the ACTIVE DRIVER PLUS).
- Check the direction rotation of the pump (three-phase version).
- It is good practice to use a discharge pipe of the same internal diameter of the pump discharge port.
- The pump can function either vertical or horizontal.



# PULSAR, DIVER AND DIVERTRON PUMP SELECTION

## EXAMPLE

Assume we wish to supply water from a nearby well to a 3-storey detached house. The installer informs us that it has 1 KITCHEN, 2 BATHROOMS and a 200 m<sup>2</sup> garden and that quietness of the pump is a requirement. Water is available 15 m deep underground.

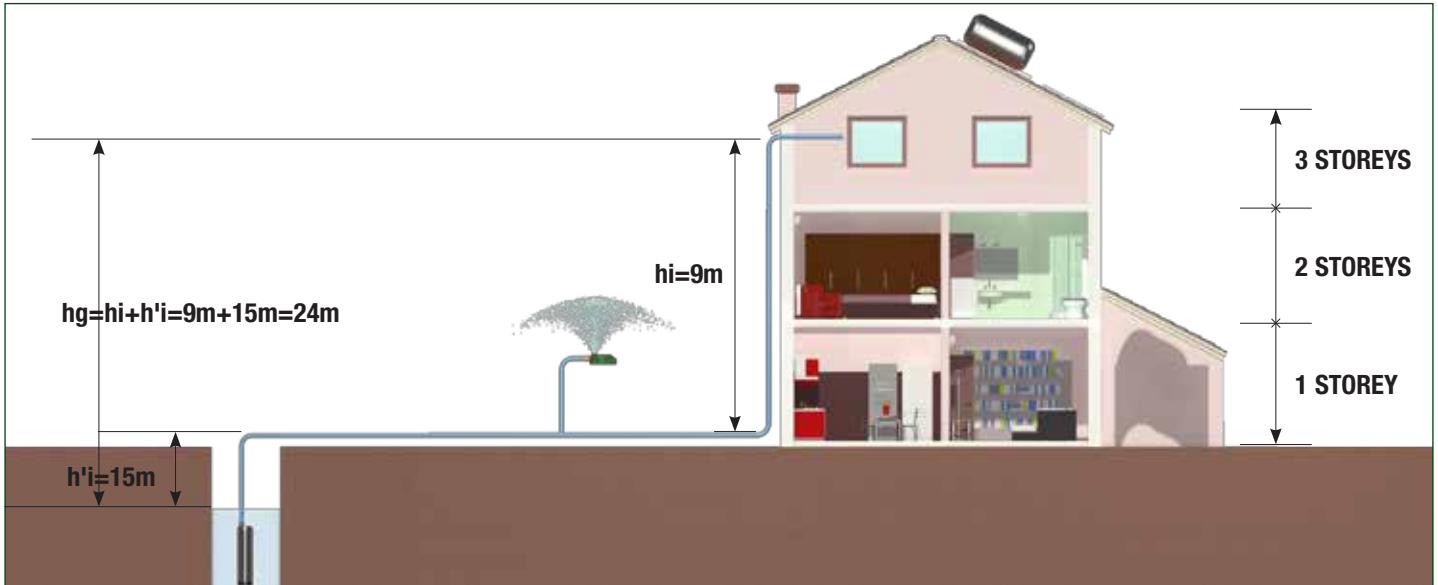

Unless otherwise indicated,  $h_p$  (system pressure drop) = 20% of  $h_g$ .  
Height of each storey = 3 m.



	KITCHEN + BATHROOM	KITCHEN + BATHROOM + WC	KITCHEN + 2 BATHROOMS	KITCHEN + 2 BATHROOMS + 100 m <sup>2</sup> GARDEN
1 STOREY	PULSAR 30/50	PULSAR 30/50	PULSAR 40/50	PULSAR 30/80
2 STOREYS	PULSAR 40/50	PULSAR 40/50	PULSAR 30/80	PULSAR 40/80
3 STOREYS	PULSAR 40/50	PULSAR 40/50	PULSAR 30/80	<b>PULSAR 40/80</b>
4 STOREYS	PULSAR 50/50	PULSAR 50/50	PULSAR 30/80	PULSAR 40/80

\* The data given in the table and in the graph curve are valid for PULSAR and PULSAR DRY pumps.

\* For the other cases not addressed in the table, consult DAB Technical Department.

\* The pumps can be single-phase or three-phase (see DAB documentation).



## THEORETICAL SELECTION

### Given data:

- N° of storeys = 3
- N° of bathrooms = 2
- 200 m<sup>2</sup> garden = 1,5 m<sup>3</sup>/h
- $h_g = 15 \text{ m (depth)} + (3 \text{ m} \times 3 \text{ storeys}) = 24 \text{ m}$

### Flow rate and pressure head (see page 6)

$$h_t = 24 \text{ m} + 4.8 \text{ m} + 20 \text{ m} = 48.8 \text{ m}$$

$$Q = 2 \text{ m}^3/\text{h} + 1,5 \text{ m}^3/\text{h} = 3,5 \text{ m}^3/\text{h}$$

For this application we need to use the theoretical selection because the example in question is not given in the table.

The solution would be that of installing a PULSAR or PULSAR DRY 40/80, as indicated by the pump performance curve.

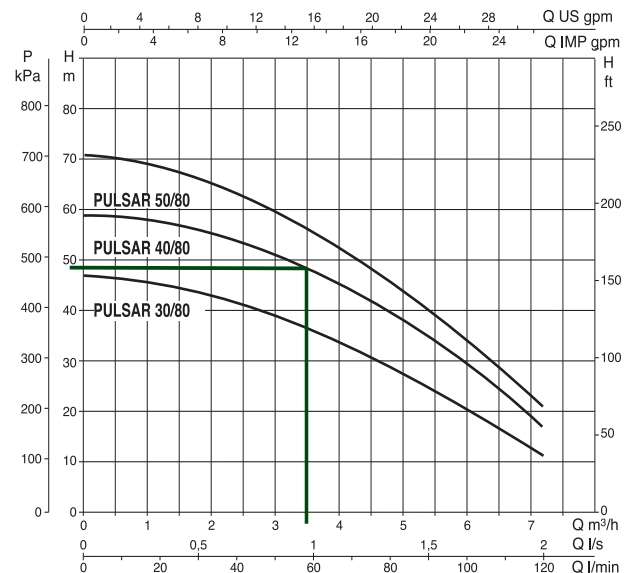

# PULSAR, DIVER AND DIVERTRON PUMP SELECTION

## EXAMPLE

Assume we wish to supply water from a nearby well to a 3-storey detached house. The installer informs us that this huose has 1 KITCHEN, 2 BATHROOMS and that quietness of the pump is a requirement. The water source is an underground tank 4 m deep. Requested integrated on/off system.

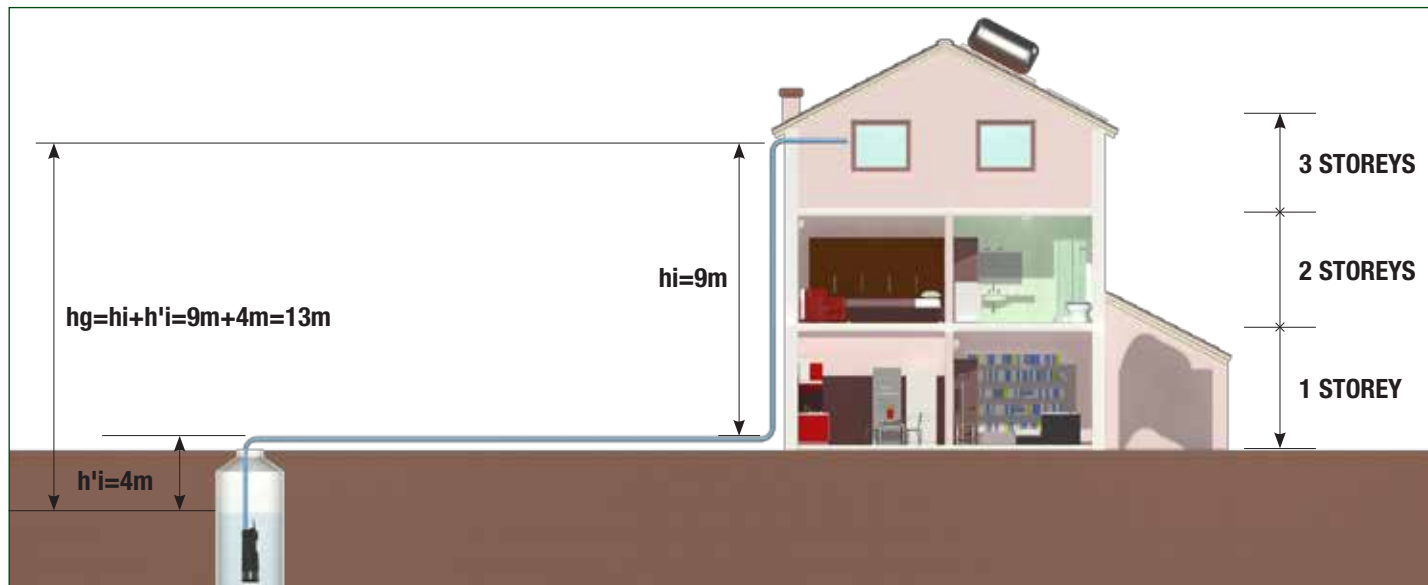

Unless otherwise indicated,  $h_p$  (system pressure drop) = 20% of  $h_g$ .  
Height of each storey = 3 m.



## THEORETICAL SELECTION

### Given data:

1. N° of storeys = 3
2. N° of bathrooms = 2
3.  $h_g = 4 \text{ m (depth)} + (3\text{m} \times 3 \text{ storeys}) = 13 \text{ m}$

**Flow rate and pressure head** (see page 6)

$$h_t = 13 \text{ m} + 2.6 \text{ m} + 20 \text{ m} = 35.6 \text{ m}$$

$$Q = 2 \text{ m}^3/\text{h}$$

The solution would be that of installing a DIVERTRON 1200 as indicated by the pump performance curve.

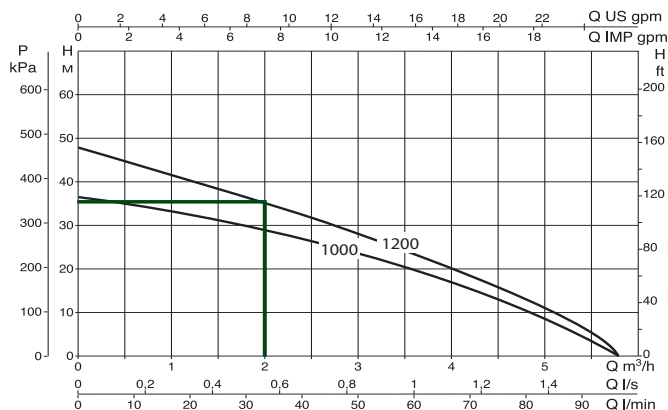

## COMPONENTS REQUIRED FOR INSTALLATION



- Divertron
- Check valve
- Pressure gauge
- Expansion vessel (2 liters)
- Pipeline (1" minimum pipe diameter)
- Power cable

**MAX installation DEPTH: 15 m**

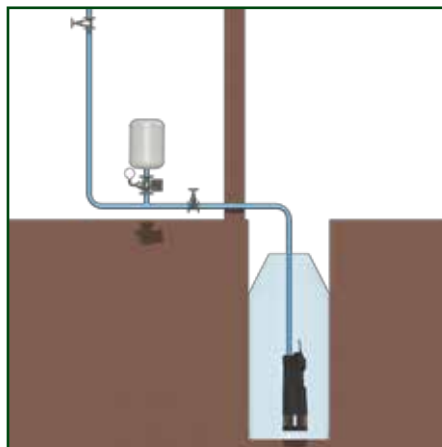

# ECONOMIC AND INSTALLATION BENEFIT OF THE ACTIVE DRIVER PLUS

## THE FUTURE WITH ACTIVE DRIVER PLUS

### COMPONENTS REQUIRED FOR INSTALLATION



- Submersible pump
- Check valve
- Pipeline
- Power cable to the pump and to the ACTIVE DRIVER PLUS
- Small expansion vessel with capacity of less than 20 litres downstream the ACTIVE DRIVER PLUS (see picture)

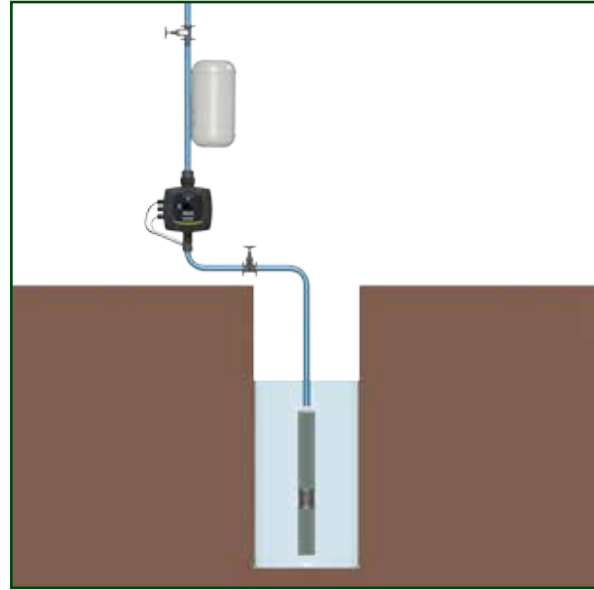

## SELECT THE CORRECT ACTIVE DRIVER PLUS:

TESLA motor	1x220 V	3x220 V	3x400 V	In	ACTIVE DRIVER PLUS
Motor 4GG M-0,37kW	●			3,3	M/M 1.1
Motor 4GG T-0,37kW		●		2,7	M/T 1.0
Motor 4GG T-0,37kW			●	1,4	T/T 3.0
Motor 4GG M-0,55kW	●			4,6	M/M 1.1
Motor 4GG T-0,55kW		●		3,3	M/T 1.0
Motor 4GG T-0,55kW			●	1,9	T/T 3.0
Motor 4GG M-0,75kW	●			6,2	M/M 1.1
Motor 4GG T-0,75kW		●		4,1	M/T 1.0
Motor 4GG T-0,75kW			●	2,4	T/T 3.0
Motor 4GG M-1,1kW	●			8,6	M/M 1.5
Motor 4GG T-1,1kW		●		5,7	M/T 2.2

TESLA motor	1x220 V	3x220 V	3x400 V	In	ACTIVE DRIVER PLUS
Motor 4GG T-1,1kW			●	3,4	T/T 3.0
Motor 4GG M-1,5kW	●			11	M/M 1.8
Motor 4GG T-1,5kW		●		7,6	M/T 2.2
Motor 4GG T-1,5kW			●	4,4	T/T 3.0
Motor 4GG M-2,2kW	●			16	No
Motor 4GG T-2,2kW		●		10,2	M/T 2.2
Motor 4GG T-2,2kW			●	5,9	T/T 3.0
Motor 4GG T-3kW		●		14,3	No
Motor 4GG T-3kW			●	8,3	T/T 5.5
Motor 4GG T-4kW		●		17,3	No
Motor 4GG T-4kW			●	10	T/T 5.5

Always select pumps with maximum pressure < 13 bar.

## THE PAST WITHOUT ACTIVE DRIVER PLUS

### COMPONENTS REQUIRED FOR INSTALLATION



- Submersible pump
- Check valve
- 5-way union
- Pressure switch
- Pressure gauge
- Expansion vessel
- Pipeline
- Electrical power and control panel
- Pump dry run protection sensor
- Power cable
- Pressure switch cable
- Level sensor cable

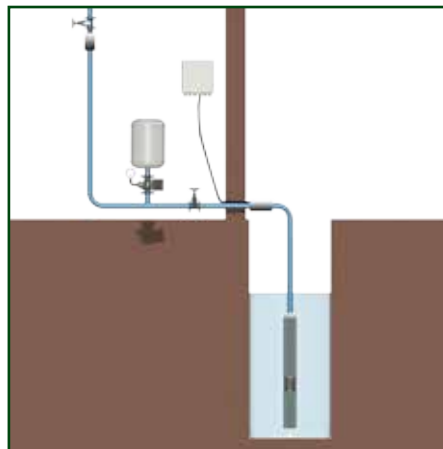

### INSTALLATION SAVING



DEPENDING ON THE TYPE OF SYSTEM, COSTS CAN BE REDUCED IN TERMS OF:

- Hours of labour.
- Expansion vessel.
- 5-way union.
- Pressure gauge.
- Electrical panel.
- Protection sensors.
- Cable length.

## FEKA, NOVA, VERTY NOVA AND NOVA UP

Submersible drainage pumps with continuous duty asynchronous motor.



FEKA 600

NOVA 300

VERTY NOVA

NOVA UP

### EXAMPLE WITH VERTY NOVA

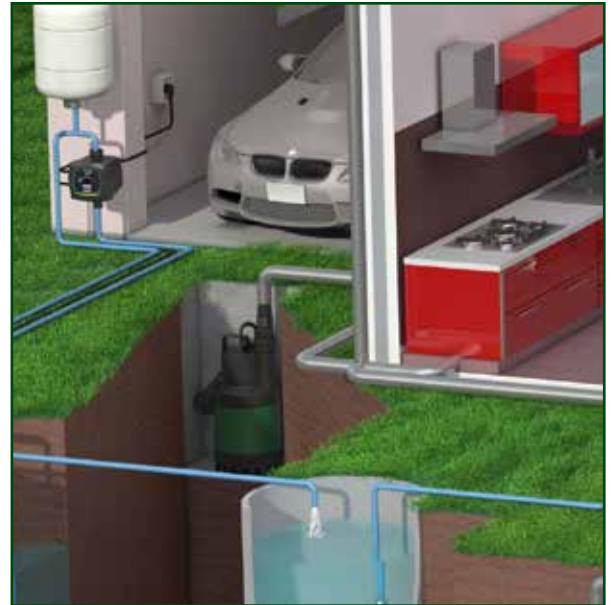

### EXAMPLE WITH NOVA UP

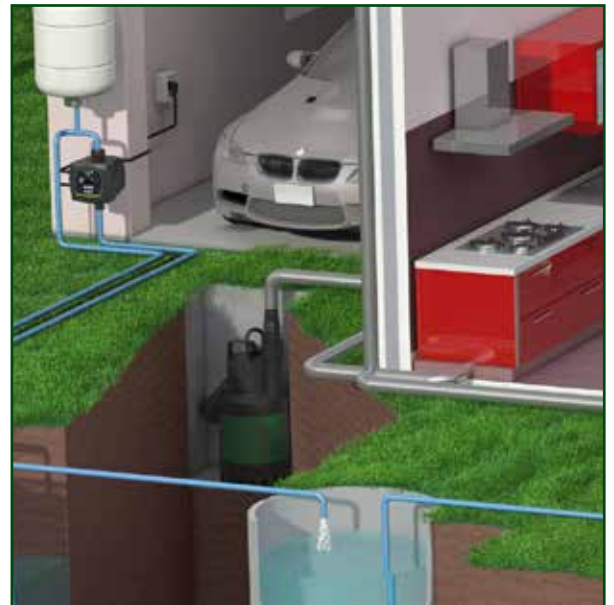

## APPLICATION



- Drainage of water from basements and garages.
- Stormwater collection pits.
- Drainage pits.
- Sucking water from tanks or rivers.
- Other applications (consult the Technical Department).
- NOVA: Ideal for pumping of greywater without stringy filaments.
- FEKA: Ideal for pumping sewage from septic tanks.

## CHARACTERISTICS



- Flow rates from 1 to 16 m<sup>3</sup>/h and with maximum head of 10.2 m.
- Water temperature range must be between 0 °C and 35 °C.
- Solid particles size handled is from 5 mm to 25 mm depending on the model (consult DAB Technical Department).
- Maximum immersion depth: 7 m.
- Lightweight for easy transportation.

## IMPORTANT



- A support must be installed to keep the pump raised from the bottom of the pit/tank so that it is not resting on the ground.
- Do not install pipes with smaller diameter than the pump discharge one.
- Always install in vertical position.
- For the version with integrated float make sure the float arm is free to move before proceeding with the installation.
- Do not power the pump if there are people in the water cistern in which the pump is installed.
- Immerse the pump completely to prevent the motor from overheating.
- Make sure there are no air pockets in the pump.



# ALL SUSPENDED SOLIDS CAN BE HANDLED

## FEKA VS - VX

Submersible centrifugal pumps in stainless steel with double mechanical seal in oil chamber.



## APPLICATION



- Lifting of sewage and civil or industrial effluent.
- Ideal for installation with FEKABOX and FEKAFOS.
- Other applications (consult DAB Technical Department).

## CHARACTERISTICS



- Pump body and impeller in stainless steel. (Feka VS)
- Fibre-reinforced technopolymer pump body and impeller. (Feka VX)
- Flow rates from 0 to 32 m<sup>3</sup>/h with maximum head of 14 m.
- The water temperature range must be between 0 °C and 35 °C.
- Maximum immersion depth 10 m.
- Handling of suspended solids with dimensions of up to 50 mm.

## IMPORTANT



- The pump can be fixed or portable, but it must always be placed in vertical position.
- A support must be installed to keep the pump raised from the bottom of the pit/tank so that it is not resting on the ground.
- The internal diameter of the pipe must be at least equal to the diameter of the pump ports.
- Immerse the pump completely to prevent the motor from overheating or provide the pit with a maximum level float.
- Make sure there are no air pockets in the pump.

## FEKAFOS

Automatic lifting station for collection and drainage of wastewater and stormwater.



### APPLICATION



- Ideal for the collection and drainage to sewerage networks of civil and industrial wastewaters.
- Ideal also for the collection of stormwater.
- Other applications (consult DAB Technical Department).

### CHARACTERISTICS



- High-density polyethylene container.
- Available volumes (200 l, 280 l and 550 l).
- Two integrated floats and lifting devices.
- Covers with hermetic gas-impermeable gasket.
- Pumps lifting device included.

## IMPORTANT



- Lifting stations prearranged with internal floats for the use of 1 or 2 single or three phase pumps (depending on the model) with integral floats. An electrical panel must be installed.
- When there are 2 pumps in the same FEKAFOS lifting station, they can run alternately.
- The pumps (to be ordered separately) are installed inside the FEKAFOS lifting station on site.
- A ball valve has to be fitted outside the tank to prevent backflow.
- For information on further accessories consult DAB Technical Department.

## FEKABOX

Automatic lifting station for collection and drainage of wastewater and stormwater.



### APPLICATION



- Ideal for the collection and drainage to sewerage networks of civil and industrial wastewaters.
- Ideal also for the collection and conveyance of stormwater.
- And for other applications (consult DAB Technical Department).

### CHARACTERISTICS



- High-density polyethylene container.
- 3 available capacities (110 l, 200 l and 280 l).
- Covers with hermetic gas-impermeable gasket.
- FEKABOX 280 is equipped with an integral 2" PVC connection kit.

## IMPORTANT



- It is not necessary to install an electrical panel.
- Station prearranged for operation with an automatic pump with integral float.
- For information on further accessories consult DAB Technical Department.

# CHOOSING A LIFTING STATION FOR STORMWATER AND SEWERAGE IS NO LONGER A PROBLEM

STORMWATER LEVEL DIFFERENCE (m)	WET SURFACE AREA (m <sup>2</sup> )		
	0-25	25-45	45-70
0,0	NOVA 180	NOVA 200 NOVA 300	FEKA 600
1,0			
2,0			
3,0	NOVA 200	FEKA 600	NOVA 600
4,0	NOVA 300		
5,0	FEKA 600		
5,5	NOVA 600	NOVA 600	NOVA 600
6,0		NOVA 600	
7,0		NOVA 600	
8,0			

STORMWATER LEVEL DIFFERENCE (m)	WET SURFACE AREA (m <sup>2</sup> )			
	0 - 25	25 - 45	45 - 70	70 - 90
0,0	FEKA VS-VX 550	FEKA VS-VX 550	FEKA VS-VX 550	2 x FEKA VS-VX 550
0,5				
1,0				
1,5				
2,0				
2,5				
3,0				
3,5				
4,0				
4,5				
5,0				
5,5				
6,0				
6,5				
7,0				
7,5	FEKA VS-VX 750	FEKA VS-VX 1000	FEKA VS-VX 1000	2 x FEKA VS-VX 1000
8,0	FEKA VS-VX 750			
8,5	FEKA VS-VX 1000			
9,0	FEKA VS-VX 1000	FEKA VS-VX 1200	FEKA VS-VX 1200	2 x FEKA VS-VX 1200
9,5	FEKA VS-VX 1000			
10,0	FEKA VS-VX 1000			
10,5	FEKA VS-VX 1200	FEKA VS-VX 1200	FEKA VS-VX 1200	2 x FEKA VS-VX 1200
11,0		FEKA VS-VX 1200		
11,5		FEKA VS-VX 1200		
12,0				
12,5				

	FEKABOX 100
	FEKABOX / FEKAFOS 200
	FEKABOX / FEKAFOS 280
	FEKAFOS 280 DOUBLE
	FEKAFOS 550

SEWERAGE LEVEL DIFFERENCE (m)	TYPE OF RESIDENCE			
	Kitchen or bathroom	Kitchen + bathroom	Kitch. + 2 bathrooms	N° OF RESIDENTIAL UNITS
0,0	FEKA VS 550	FEKA VS - VX 550	FEKA VS - VX 550	1
0,5				
1,0				
1,5				
2,0				
2,5				
3,0				
3,5				
4,0				
4,5				
5,0				
5,5				
6,0				
6,5				
7,0				
	FEKA VS 750	FEKA VS - VX 750		

## NOTE



Maximum volume of waste water in single-family domestic systems

Kitchen + bathroom = 7 m<sup>3</sup>/h

Kitchen + 2 bathrooms = 12 m<sup>3</sup>/h

Kitchen + 3 bathrooms = 16 m<sup>3</sup>/h

For the selection of these lifting stations we have considered a drainage pipeline length of 20 metres and the same diameter of the discharge port as the corresponding FEKA unit.

\*\* To install FEKAFOS consider the electrical panels shown in the annexed tables.

\*\* For greater lengths consult DAB technical department.

Surfaces (m <sup>2</sup> )	0 - 25	25 - 45	45 - 70	70 - 90
Flow Rate (m <sup>3</sup> /h)	0 - 3	3 - 5,5	5,5 - 8,4	8,4 - 10,8

\*\* For the calculation of stormwater pumps we considered average annual rainfall of 120 mm/h

## VOLUME OF CISTERN IN SYSTEMS FOR TREATMENT OF EFFLUENT AND STORM WATER:

$$V \text{ (litres)} = \frac{0,3 \times Q \text{ (m}^3\text{/h)} \times 1000}{\text{N}^\circ \text{ starts / hour}}$$

**V** = Cistern volume in litres.

**Q** = Pump flow rate in m<sup>3</sup>/h.

**N° of starts** = consider 12.

# CHOOSING A LIFTING STATION FOR WASTEWATERS HAS NEVER BEEN SO EASY

LEVEL DIFFERENCE (m)	TYPE OF RESIDENCE			N° OF RESIDENTIAL UNITS
	Kitchen + bathroom	Kitch. + 2 bathrooms	Kitch. + 3 bathrooms	
0,0	FEKA VS-VX 550 ELECTRICAL PANELS: ED1,3M ED1,3T	FEKA VS-VX 550 ELECTRICAL PANELS: ED1,3M ED1,3T + ANTIROTATION BASE	2 x FEKA VS-VX 550 ELECTRICAL PANELS: E-BOX + 2 ANTIROTATION BASES	2 x FEKA VS-VX 550 ELECTRICAL PANELS: E-BOX + 2 ANTIROTATION BASES
0,5				
1,0				
1,5				
2,0				
2,5				
3,0				
3,5				
4,0				
4,5				
5,0	FEKA VS-VX 750 ELECTRICAL PANELS: ED1,3M ED1,3T + ANTIROTATION BASE	FEKA VS-VX 750 ELECTRICAL PANELS: ED1,3M ED1,3T + ANTIROTATION BASE	2 x FEKA VS-VX 750 ELECTRICAL PANELS: E-BOX + 2 ANTIROTATION BASES	2 x FEKA VS-VX 750 ELECTRICAL PANELS: E-BOX + 2 ANTIROTATION BASES
5,5				
6,0				
6,5	FEKA VS-VX 1000 ELECTRICAL PANELS: ED1,3M ED1,3T	FEKA VS-VX 1000 ELECTRICAL PANELS: ED1,3M ED1,3T + ANTIROTATION BASE	2 x FEKA VS-VX 1000 ELECTRICAL PANELS: E-BOX + 2 ANTIROTATION BASES	2 x FEKA VS-VX 1000 ELECTRICAL PANELS: E-BOX + 2 ANTIROTATION BASES
7,0				
7,5	FEKA VS-VX 1000 ELECTRICAL PANELS: ED1,3M ED1,3T	FEKA VS-VX 1200 ELECTRICAL PANELS: ED1,3M ED1,3T + ANTIROTATION BASE	2 x FEKA VS-VX 1000 ELECTRICAL PANELS: E-BOX + 2 ANTIROTATION BASES	2 x FEKA VS-VX 1000 ELECTRICAL PANELS: E-BOX + 2 ANTIROTATION BASES
8,0				
8,5				
9,0	FEKA VS-VX 1200 ELECTRICAL PANELS: ED1,3M ED1,3T	FEKA VS-VX 1200 ELECTRICAL PANELS: ED1,3M ED1,3T + ANTIROTATION BASE	2 x FEKA VS-VX 1200 ELECTRICAL PANELS: E-BOX + 2 ANTIROTATION BASES	2 x FEKA VS-VX 1200 ELECTRICAL PANELS: E-BOX + 2 ANTIROTATION BASES
9,5				
10,0				
10,5				
11,0				
11,5				

FEKABOX 100
FEKABOX / FEKAFOS 200
FEKABOX / FEKAFOS 280
FEKAFOS 280 DOUBLE
FEKAFOS 550

## NOTE

- For the selection of these lifting stations we considered a drainage pipeline length of 20 metres and the same diameter of the discharge port as the corresponding FEKA unit.
- These tables show some examples based on standard value. For a correct selection, please contact our sales network.



LEVEL DIFFERENCE (m)	TYPE OF RESIDENCE			N° OF RESIDENTIAL UNITS				
	Kitchen + bathroom	Kitch. + 2 bathrooms	Kitch. + 3 bathrooms					
0,0	2 x FEKA VS-VX 750 ELECTRICAL PANELS: E-BOX + 2 ANTIROTATION BASES	2 x FEKA VS-VX 1200 ELECTRICAL PANELS: E-BOX + 2 ANTIROTATION BASES	2 x FEKA VS-VX 1200 ELECTRICAL PANELS: E-BOX + 2 ANTIROTATION BASES	2				
0,5								
1,0								
1,5								
2,0								
2,5								
3,0								
3,5								
4,0					2 x FEKA VS-VX 1000 ELECTRICAL PANELS: E-BOX + 2 ANTIROTATION BASES			
4,5								
5,0								
5,5	2 x FEKA VS-VX 1200 ELECTRICAL PANELS: E-BOX + 2 ANTIROTATION BASES							
6,0								
6,5								
7,0								
7,5								
8,0								



## E.BOX

Electronic control panel.



## CHARACTERISTICS



- Electronic control panel for the protection and automatic operation of one or two submersible or pressurizing pumps both single-phase and three-phase, installed in domestic, civil and industrial environments.
- Possibility of managing up to 2 pumps.
- Ideal for the management of FEKAFOS waste water collection tanks with two submersible pumps.
- Large 3" display (D versions only) for consistently monitoring the status of pumps and sensors (level or pressure) or, in more general terms, the connected input signals.
- Wizard that provides step by step installation instructions during the first installation (D versions only).
- Remits to view the complete log of pump and panel errors (D versions only).
- Predisposed for monitoring via GSM.

## APPLICATION



- Driving of pumps installed for emptying waste water or draining water tanks.
- Driving of pumps used to fill tanks or water filling stations.
- Driving of pumps installed in water pressurisation systems.

## VERSIONS



- E.box BASIC (Single-phase only):
  - Nominal tension of power: 1x230 V
  - Frequency: 50 - 60 Hz
  - Maximum power range of use: 2,2 kW + 2,2 kW
  - Maximum current: 12 A + 12 A
- E.box PLUS (Single-phase or three-phase with automatic selection):
  - Nominal tension of power: 1x 230 V / 3 x 230 V - 3 x 400 V (automatic selection)
  - Frequency: 50 - 60 Hz
  - Maximum power range of use: 5,5 kW + 5,5 kW
  - Maximum current: 12 A + 12 A

## COMPATIBLE ACCESSORIES

	<b>ORANGE FLASHING LAMP 230 V</b> With 5 W incandescent light bulb		<b>ON-OFF FLOAT SWITCH</b> 2 wire NO/NC Bulb or standard, available with 5, 10, or 20 meters 3x1 H07RN-F cable
	<b>ELECTRODE PROBE</b> Suitable for conductive liquids with maximum temperature +40 °C. To be connected using a 1,5 mm <sup>2</sup> cable with 550 V insulation capacity. Sensitivity: ≤ 53 Kohm		<b>0-5 m - 20 m LEVEL TRANSDUCERS</b>
	<b>DRY RUN PROTECTION PRESSURE SWITCH</b>		<b>CAPACITOR KIT</b>

# THE WC WHEREVER YOU DESIRE

## GENIX

Automatic lifting stations with macerator integrated.



## CHARACTERISTICS



- Equipped with everything you need for quick and easy installation.
- Fittings with non-return valves integrated, hose clamps, hose adaptors, ground-fixing screws, anti-vibration rubber nubs, and illustrated quick guide.
- Tank capacity 9,2 litres.
- Maximum head 8 m, maximum flow rate 114 l/min.
- Compatible with DIN EN 12050-3:2001-2005.
- Maximum temperature of pumped liquid 50°C.
- Simplified access to unblock the grinding.
- Easy access to: capacitor, electronic board and pressure switch.
- Draining tap (draining pipe included).
- Performant and silent motor.
- Newly designed macerator, robust, long lasting and reliable.
- Anti-odours system.
- Comfort version with noise absorbing shield, that further reduces the noise emissions by 5 db.
- Possibility of installing an acoustic alarm signal (optional).



## APPLICATION



- Lifting station for wc, shower, sink or bidet waste water, when the water cannot be expelled by gravity.
- To be used whenever the addition of a new toilet is required, in case of new installations, refurbishments, or structural changes.

## IMPORTANT



- Comply with the indications of the drawings below as far as the minimum delivery piping diameters.
- Comply with the requirements on minimum inclination of the Genix input piping indicated in the tables below.
- Do not exceed the maximum flow for each connected service.

## GENIX 110



### CONNECTION TO:

- 1 WC
- 1 more inlet (1 washbasin)

## GENIX 130



### CONNECTION TO:

- 1 WC
- 3 more inlets (1 washbasin, 1 shower and 1 bidet)

# CIRCULATING WATER FOR A LIFETIME

## WET ROTOR CIRCULATORS

ONLY FOR  
EXTRA  
MARKETS  
EU

Circulators for heating and air conditioning systems



VA



DPH (DOUBLE)



## CHARACTERISTICS



- Flow rates from 1 to 78 m<sup>3</sup>/h and with maximum pressure head of 18 m, depending on the model.
- Temperature range from -10 °C to +110 °C.
- Pumped liquid characteristics: clean, free of solids and mineral oils, non-viscous, chemically neutral and approximating the properties of water.
- Motor casing in diecast aluminium.
- Impeller in technopolymer.
- Threaded or flanged unions depending on the model.
- 2 or 3 operating speeds depending on the model.

## IMPORTANT



- The terminal box must never be below the pump.
- Always install the pump in vertical position (see photo) to avoid premature wear of bearing and seals.
- 30% maximum glycol contents. (60% for VSA)
- In case of heat shells, ensure the motor casing condensate discharge nozzles are not clogged or partially obstructed.
- The circulator is maintenance free.
- The unit can be supplied complete with unions and other accessories (consult DAB Technical Department).

## APPLICATION



- Utilised also in solar heating circuits. (VSA)
- Circulating water in heating and air conditioning systems.
- Available also for recirculation of sanitary water (bronze pump body). (VS)
- Other applications (consult DAB Technical Department).

# CIRCULATOR SELECTION

## EXAMPLE

Assume you need a circulator for a standard heating system.

We know that the boiler heating capacity is 23700 kcal/h and that the system pressure drop is approximately 4 m.w.c.

### QUICK SELECTION

SYSTEM PRESSURE DROP (m.w.c.)	BOILER CAPACITY (kcal/h)		
	7000-14000	15000-22000	23000-30000
	THREADED	THREADED	THREADED
1	VA 25	VA 25	VA 25
2	VA 25	VA 25	VA 25
3	VA 35	VA 55	VA 35
4	VA 35	VA 55	<b>VA 55</b>
5	VA 55	VA 65	A 50/180
6	VA 65	A 56/180	A 56/180
7	A 80/180	A 80/180	A 80/180
8	A 80/180	A 80/180	A 80/180

\* These circulators can function with single-phase or three-phase power supplies (see Price List).

\* The circulator dimensions are given in the Technical Catalogue.

\* For the other cases not addressed in the table, consult DAB Technical Department.



## THEORETICAL SELECTION

### Given data:

- Boiler power = 23700 kcal/h
- System pressure drop = 4 m.w.c.

**Flow rate:** (see page 6)

$$Q \text{ (l/s)} = \frac{\text{BOILER CAPACITY (kcal/h)}}{\Delta t^\circ \times 3600} = \frac{23700 \text{ kcal/h}}{20 \times 3600} = 0,33$$



$$Q = 1,2 \text{ m}^3/\text{h}$$

The 3 curves on the graph correspond to the three operating speeds of this circulator. In this case we find the point at speed 3.

### VA 55

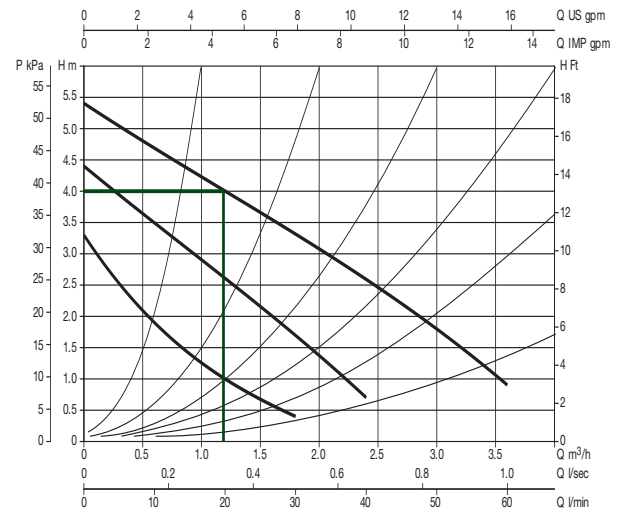



# SOLAR HEATING CIRCULATOR SELECTION

## EXAMPLE

Assume we need to select a circulator suitable for the primary circuit in a solar panels system for domestic hot water. We know that the effective surface area of each panel is 2 m<sup>2</sup> and that there are 10 solar panels installed. The total pressure drop for the circuit is 4 m.w.c.

### QUICK SELECTION

SYSTEM PRESSURE DROP (m.w.c.)	SOLAR PANELS TOTAL SURFACE AREA (m <sup>2</sup> )		
	4 - 8	10 - 20	20 - 24
1			
1,5			
2			
2,5			
3			
3,5			
4			
4,5			

	VSA 35
	VSA 55

- \* These circulators can function with single-phase or three-phase power supplies (refer to DAB documentation).
- \* For the other cases not addressed in the table, consult the DAB Technical Department.



## THEORETICAL SELECTION

### Given data:

- Number of solar panels = 10
- Effective surface area of each panel = 2 m<sup>2</sup>
- System pressure drop = 4 m.w.c.
- We assume that the flow rate per square metre of panels is 60 l/h.

**Flow rate:** (see page 6)

$$Q \text{ (m}^3\text{/h)} = \frac{60 \text{ (l/h} \times \text{m}^2) \times 2 \text{ m}^2 \times 10 \text{ panels}}{1000} = 1,2 \text{ m}^3\text{/h}$$



→ Q = 1,2 m<sup>3</sup>/h

### VSA 55

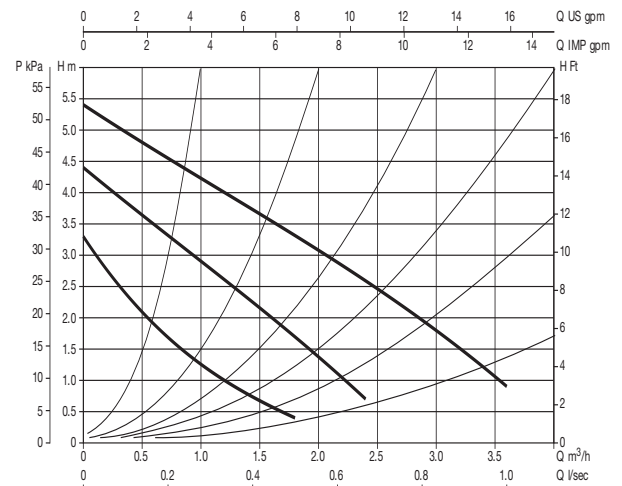

# CIRCULATING WATER FOR A LIFETIME

## ELECTRONIC CIRCULATOR

Circulators for heating and air conditioning systems.



EVOSTA



EVOTRON



EVOPLUS

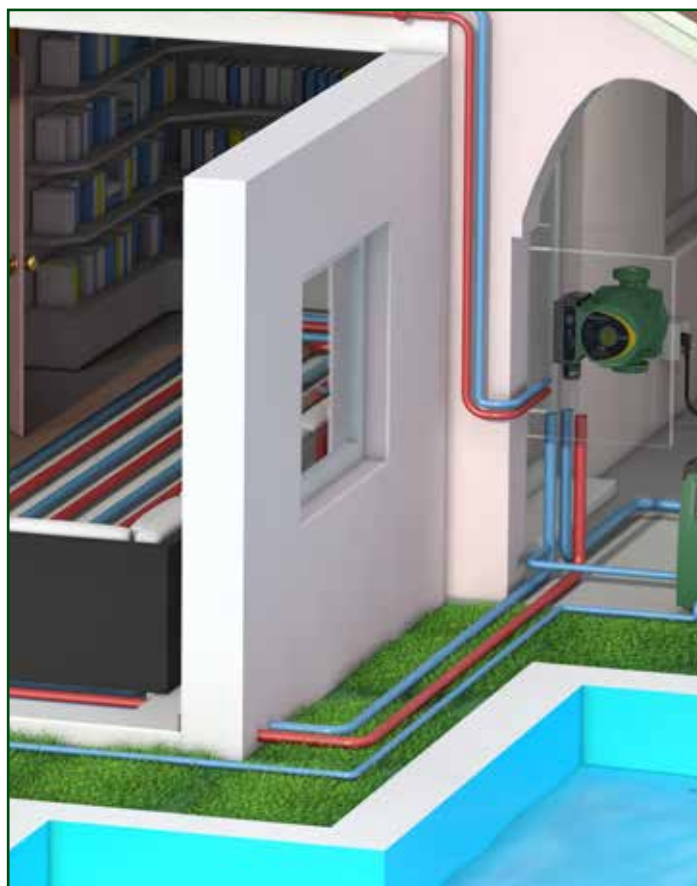

## CHARACTERISTICS



- Flow rates from 0.3 to 75.6 m<sup>3</sup>/h and with maximum pressure head of 18 m, depending on the model.
- Temperature range from -10 °C to +110 °C.
- Pumped liquid characteristics: clean, free of solids and mineral oils, non-viscous, chemically neutral and approximating the properties of water.
- Motor casing in diecast aluminium.
- Impeller in technopolymer.
- Threaded or flanged unions depending on the model.
- Different operating modes depending on the model.

## APPLICATION



- Circulating water in heating and air conditioning systems.
- Utilised also in solar heating circuits. (SOL)
- Available also for recirculation of sanitary water (bronze pump body). (SAN)
- Other applications (consult DAB Technical Department).

## IMPORTANT



- Always install the pump in a vertical position (see photo) to avoid premature wear of bearing and seals.
- Always install the pump with the motor axis in horizontal position (see photo), to avoid early wear of the circulator.
- Terminal box must never be below the pump.
- 30% maximum glycol content.
- In the case of heat shells, ensure the motor casing condensate discharge nozzles are not clogged or partially obstructed.
- The circulator is maintenance free.
- The unit can be supplied complete with unions and other accessories (consult DAB Technical Department).

# HEAD VS LOAD LOSSES

## EXAMPLE

\* Circulator head:  
 $\Delta p = 1,9 - 1,5 \text{ bar}$   
 $= 0,4 \text{ bar} = 4 \text{ m}$

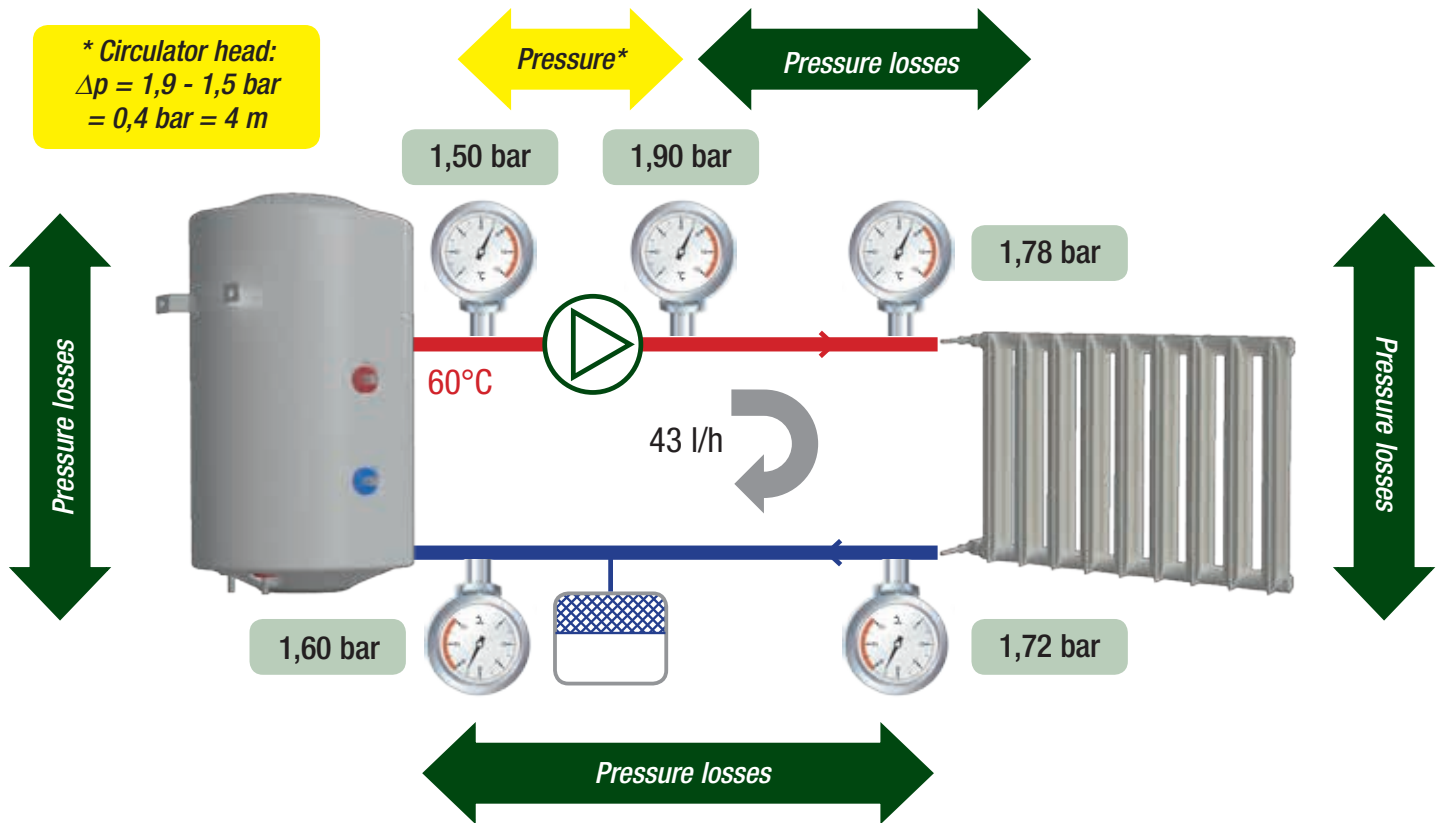

## LOCALIZED FLOW RESISTANCE AT 80°C AND WATER SPEED OF 1 M/S

Type of resistance (size)	3/8" - 1/2"	3/4" - 1"	1 1/4" - 2"	> 2"
Fan coil			1500	
Radiator			149	
Boiler			149	
Three-way valve	495	495	396	396
Four-way valve	297	297	198	198
Heating body angle valve	198	198	149	-
Heating body straight valve	421	347	297	-
Check valve	149	99	50	50
Butterfly valve	173	99	74	50
Reduced bore ball valve	10	10	5	5
Full bore ball valve	80	50	40	30
Full bore gate valve	10	10	5	5
Reduced bore gate valve	60	50	40	30
90° bend	75	50	25	20
U bend	99	75	40	25
Bottleneck			50	
Expansion joint			25	

The numbers in the table refer to the localised pressure losses in mm. of column of water

# THE RIGHT CONFIGURATION FOR THE RIGHT SYSTEM

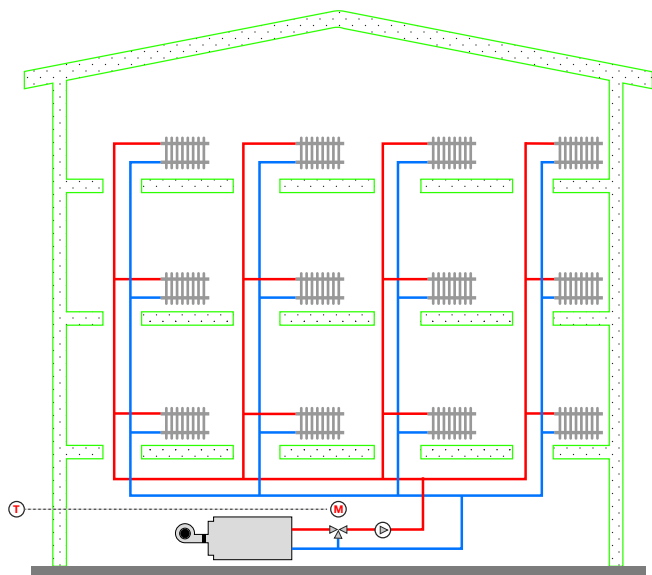

## CONSTANT SPEED

It must be used with constant flow rate primary or secondary circuits, or with column systems without thermostatic valves.

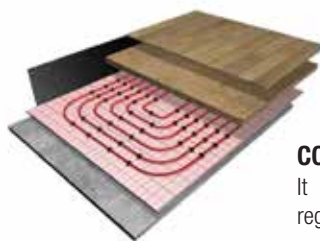
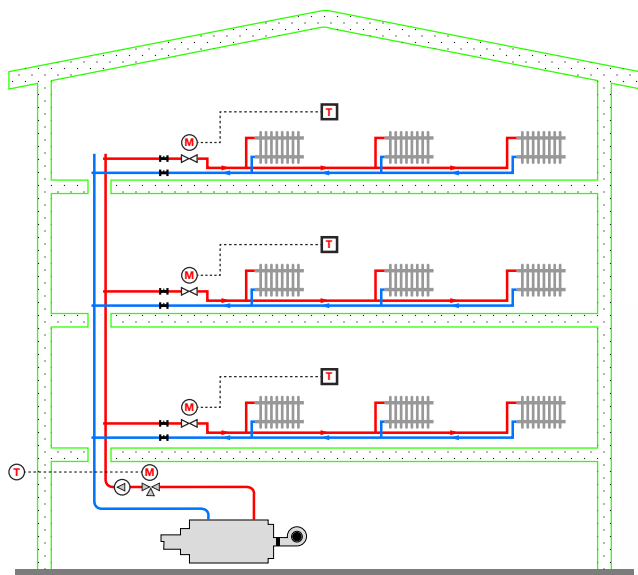

## CONSTANT DIFFERENTIAL PRESSURE

It must be used with floor systems or systems regulated by zone valves with thermostat.

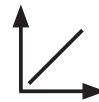
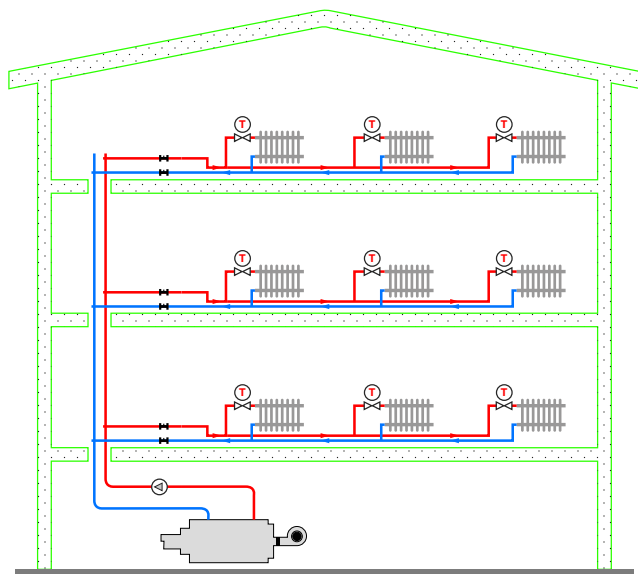

## PROPORTIONAL DIFFERENTIAL PRESSURE

It must be used with thermostatic valves.



# ELECTRONIC CIRCULATOR SELECTION

## EXAMPLE

Assume we need a circulator for a standard heating system.

We know that the boiler heating capacity is 16000 kcal /h and that the system pressure drop is approximately 4 m.w.c.

### QUICK SELECTION

SYSTEM PRESSURE DROP (m.w.c.)	BOILER CAPACITY (kcal/h)		
	7000-14000	15000-22000	23000-30000
	THREADED	THREADED	THREADED
1	EVOTRON 40/EVOSTA 40-70	EVOTRON 40/EVOSTA 40-70	EVOTRON 40/EVOSTA 40-70
2	EVOTRON 40/EVOSTA 40-70	EVOTRON 40/EVOSTA 40-70	EVOTRON 40/EVOSTA 40-70
3	EVOTRON 40/EVOSTA 40-70	EVOTRON 40/EVOSTA 40-70	EVOTRON 60/EVOSTA 40-70
4	EVOTRON 60/EVOSTA 40-70	<b>EVOTRON 60/EVOSTA 40-70</b>	EVOTRON 60/EVOSTA 40-70
5	EVOTRON 60/EVOSTA 40-70	EVOTRON 60/EVOSTA 40-70	EVOTRON 80
6	EVOTRON 60/EVOSTA 40-70	EVOTRON 80	EVOTRON 80
7	EVOTRON 80	EVOPLUS 80	EVOPLUS 80
8	EVOTRON 80	EVOPLUS 110	EVOPLUS 110

\* For the other cases not addressed in the table, consult DAB Technical Department.



## THEORETICAL SELECTION

### Given data:

- Boiler capacity = 16000 kcal/h
- System pressure drop = 4 m.w.c.

**Flow rate:** (see page 6)

$$Q \text{ (l/s)} = \frac{\text{BOILER CAPACITY (kcal/h)}}{\Delta t^\circ \times 3600} = \frac{16000 \text{ kcal/h}}{20 \times 3600} = 0,22$$



**Q = 0,8 m³/h**

In this case we find the point at speed 2.

### EVOSTA

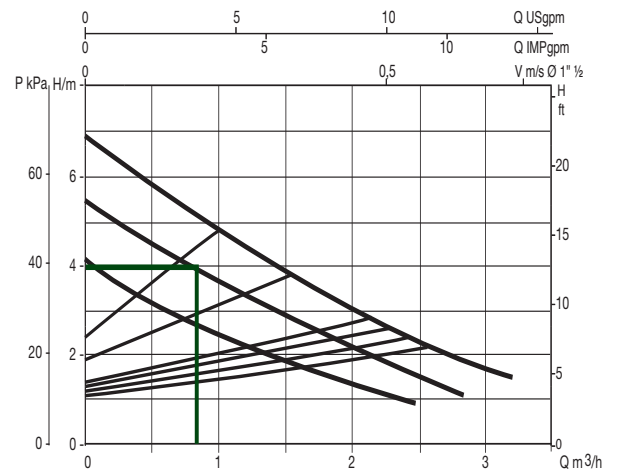

# SOLAR PANEL SYSTEM CIRCULATION

## SOLAR CIRCULATOR

Solar panel system circulation.



EVOTRON SOL



## CHARACTERISTICS



- Flow rates from 0,4 a 2,6 m<sup>3</sup>/h and with maximum head of 8 m, depending on the model.
- Temperature range from -10 °C a +110 °C (Temperature peaks up to 140 °C).
- Pumped liquid characteristics: clean, free of solids and mineral oils, non-viscous, chemically neutral and approximating the properties of water (glycol max 60 %).
- Motor casing in diecast aluminium.
- Impeller in technopolymer.
- Threaded or flanged unions depending on the model.
- Different operating modes depending on the model.
- Special cataphoresis coating on the pump body, which guarantees better resistance to glycol aggression.

## APPLICATION



- Pump suitable for vector fluid circulation in solar panel systems.
- Water circulation in heating and air conditioning systems requiring glycol percentages exceeding 30 %.

## IMPORTANT



- Always install the pump in vertical position (see photo) to avoid premature wear of bearing and seal.
- Always install the pump with the motor axis in horizontal position (see photo), to avoid early wear of the circulator.
- The terminal box must never be below the pump.
- 60% maximum glycol contents.
- In case of shells insulation, ensure the motor casing condensate discharge nozzles are not clogged or partially obstructed.
- The circulator is maintenance free.
- The unit can be supplied complete with unions and other accessories (consult DAB Technical Department).

# SOLAR HEATING CIRCULATOR SELECTION

## EXAMPLE

Assume we need to select a circulator suitable for the primary circuit in a solar panels system for domestic hot water. We know that the effective surface area of each panel is 2 m<sup>2</sup> and that there are 10 solar panels installed. The pressure drop of the circuit is 4 m.w.c.

### QUICK SELECTION

SYSTEM PRESSURE DROP (m.w.c.)	SOLAR PANELS TOTAL SURFACE AREA (m <sup>2</sup> )		
	4 - 8	10 - 20	20 - 24
1			
1,5			
2			
2,5			
3			
3,5			
4			
4,5			

	EVOTRON SOL 40
	EVOTRON SOL 60

\* For the other cases not addressed in the table, consult DAB Technical Department.



## THEORETICAL SELECTION

### Given data:

1. Number of solar panels = 10
2. Effective surface area of each panel = 2 m<sup>2</sup>
3. System pressure drop = 4 m.w.c.
4. We assume that the flow rate per square metre of panels is 60 l/h.

**Flow rate:** (see page 6)

$$Q \text{ (m}^3\text{/h)} = \frac{60 \text{ (l / hm}^2\text{)} \times 2\text{m}^2 \times 10 \text{ panels}}{1000} = 1,2 \text{ m}^3\text{/h}$$



→ Q = 1,2 m<sup>3</sup>/h

# CIRCULATING WATER FOR A LIFETIME

## EUROSWIM

Swimming pool centrifugal pumps.



## CHARACTERISTICS



- Extremely silent running (53-64 dB).
- Corrosion resistant materials, fiberglass reinforced technopolymer, cathaphoresis coating for the metal components.
- Flow rates from 0,4 to 42 m<sup>3</sup>/h and with maximum head of 22 m.
- Maximum ambient temperature +50 °C.
- Internal filter with smooth surface to simplify cleaning.

## APPLICATION



- For domestic and residential swimming pools.
- For agricultural and industrial water treatment.
- For clean or slightly dirty water with solids particles or fibers in suspension.
- Water circulation in swimming pools filtration systems.

## EUROSWIM (for private application)

SWIMMING POOL APROXIMATE DIMENSIONS (m)	WATER VOLUME (mc)	WATER FLOW (mc/h)	MODEL
8 x 4	from 35 to 40	9	EUROSWIM 50 EUROSWIM 75
from 8 x 4 to 10 x 5	from 50 to 70	15	EUROSWIM 75 EUROSWIM 100
from 10 x 5 to 12 x 5	from 70 to 90	20	EUROSWIM 150
from 11 x 6 to 12 x 6	from 90 to 110	20	EUROSWIM 150 EUROSWIM 200

## EUROSWIM (for community swimming pool and SPA)

SWIMMING POOL APROXIMATE DIMENSIONS (m)	WATER VOLUME (mc)	WATER FLOW (mc/h)	MODEL
8 x 4	from 35 to 40	14	EUROSWIM 100 EUROSWIM 150
from 8 x 4 to 10 x 5	from 50 to 70	24	EUROSWIM 150 EUROSWIM 200
from 10 x 5 to 12 x 5	from 70 to 90	30	EUROSWIM 200 EUROSWIM 300
from 11 x 6 to 12 x 6	from 90 to 110	40	EUROSWIM 300



A large grid of graph paper for taking notes, consisting of 20 columns and 30 rows of small squares.





WATER • TECHNOLOGY

Via Marco Polo, 14 - Mestrino (PD) Italy - Tel. +39.049.5125000 - Fax +39.049.5125950



**DAB PUMPS LTD.**

Unit 4 and 5, Stortford Hall Industrial Park  
Dunmow Road, Bishops Stortford, Herts  
CM23 5GZ - UK  
salesuk@dwtgroup.com  
Tel. +44 1279 652 776  
Fax +44 1279 657 727



**DAB PUMPS B.V.**

Albert Einsteinweg, 4  
5151 DL Drunen - Nederland  
info.netherlands@dwtgroup.com  
Tel. +31 416 387280  
Fax +31 416 387299



**DAB PUMPS B.V.**

Brusselstraat 150  
B-1702 Groot-Bijgaarden - Belgium  
info.belgium@dwtgroup.com  
Tel. +32 2 4668353  
Fax +32 2 4669218



**DAB PUMPEN DEUTSCHLAND GmbH**

Tackweg 11  
D - 47918 Tönisvorst - Germany  
info.germany@dwtgroup.com  
Tel. +49 2151 82136-0  
Fax +49 2151 82136-36



**PUMPS AMERICA, INC. DAB PUMPS DIVISION**

3226 Benchmark Drive  
Ladson, SC 29456 USA  
info.usa@dwtgroup.com  
Tel. 1-843-824-6332  
Toll Free 1-866-896-4DAB (4322)  
Fax 1-843-797-3366



**DAB PUMPS IBERICA S.L.**

Parque Empresarial San Fernando  
Edificio Italia Planta 1ª  
28830 - San Fernando De Henares - Madrid  
Spain  
info.spain@dwtgroup.com  
Tel. +34 91 6569545  
Fax: +34 91 6569676



**OOO DWT GROUP**

100 bldg. 3 Dmitrovskoe highway  
127247 Moscow - Russia  
info.russia@dwtgroup.com  
Tel. +7 495 739 52 50  
Fax +7 495 485-3618



**DWT South Africa**

Podium at Menlyn,  
3rd Floor, Unit 3001b, 43 Ingersol Road,  
C/O Lois and Atterbury street,  
Menlyn, Pretoria, 0181,  
South-Africa  
info.sa@dwtgroup.com  
Tel +27 12 361 3997  
Fax +27 12 361 3137